

## COMPONENT FOR GAS METER

(ONLY FOR PRE-QUALIFIED VENDORS)

(BY INVOKING PPRA CLAUSES 42(D)(I) & (II) "NEGOTIATED TENDERING" (VENDORIZED ITEMS))

(UNDER SINGLE STAGE ONE ENVELOPE BIDDING PROCEDURE)

AS PER PPRA RULES 2004

**TENDER ENQUIRY NO:  
SSGC/LP/NT/PQ/PT/2048093**

Bid Closing date & time: 23-01-2025 at 1030 hrs

Bid Opening date & time: 23-01-2025 at 1100 hrs

Supplier must be active in FBR Active Tax Payer List (ATL)  
Sealed quotation of above referred requirement to be submitted in PKR

### Venue:

Tender Room, CRD Building, Ground Floor

SSGC Head office complex Karachi -75300

Ph. +92-21-99021024,+92-21-99021173,+92-21-99021116.

**Earnest Money (Fixed Bid Bond): PKR. 101,300/-**



"Note: Tender document is also available online on SSGC website for view only. Bidder is eligible to participate in bidding process only after purchasing the tender documents from Tender Room SSGC Head Office as per the procedure mentioned in the Press Publication / SSGC website. It is mandatory for bidders to attach original Token Slip in front of the Sealed Envelope (issued at the time of Purchasing) as an evidence that supplier has purchased the Tender documents. Further, any Corrigendum/Clarifications/Addendums/Extensions issued to be notified to only those bidders who have purchased Tender documents."

**Sui Southern Gas Company Limited**

Procurement Department

ST-4/B, Block-14, Sir Shah Sulaiman Road, Gulshan-e-Iqbal, Karachi-Pakistan

Phone: +92-21-99021223,

Fax: +92-21-99231583

[www.ssgc.com.pk/ssgc](http://www.ssgc.com.pk/ssgc)

# Sui Southern Gas Company Limited

## Schedule of Requirement & Bid Form

SECTION - 3

RFQ Number	SSGC/LP/NT/PQ/PT/2048093	Open Bidding Date	03-JAN-25 09:21
Document Number	2048093	Close Bidding Date	23-JAN-25 10:30

S#	Item Code	Item Description	Unit	Quantity	Make / Brand	Unit Price inclusive of all discount (if any) & Exclusive of GST	Value PKR
1	2	3	4	5		6	7 = 5 x 6
1	51042803	COMPONENTS FOR 3RD GENERATION G4 GAS METERS   METALIC DEFLECTOR WITH PLASTIC GRID ASSEMBLY   MP-MDPGA-DV355R03	Each	200000			

**Delivery Schedule:** Delivery Schedule: 30,000 Pieces Per Month. The delivery shall start within 15 days after receipt of PO. Samples must be provided by the bidders upon request.

**Total Fix Bid Bond Amount PKR:** 101,300

**NOTE:**

- The quoted unit price and corresponding total amount shall be inclusive of all duties and taxes and discount (if any) except General Sales Tax. (GST). Sales Tax will be applicable as per GST act and subsequent amendments of time to time. GST will be reimbursed to manufacturer and importers only subject to production of paid invoice.
- Bidders are essentially required to quote on bid form. Rates quoted on other than bid form will not be entertained.
- Queries / complaints regarding subject tender enquiry shall be addressed to GM(P) / DGM(P) in writing
- EVALUATION CRITERIA :** Order will be placed on the Lowest Technically / Commercially Compliant bidder (s), unless specified otherwise.
- In case when bidder submit alternate bids, a separate Bid Bond for each bid is required. All the bidders are advised to furnish fixed bid security amount appearing in price schedule/BOQ otherwise bid will be liable for rejection. The submission of fixed amount of bid security is also mandatory for all the bids valuing RS.500,000/- or less.
- Any Bidder who change/amend the BOQ or Price Schedule (Description, Quantity, UOM etc.) will render the bid as conditional bid and will be liable for rejection.
- Bid bond submission (2%) of the bid amount as mentioned in the clause 9 of General Terms & Conditions, to be treated as null & void, however, other contents of clause 9 will remain unchanged.
- All offers shall remain valid up to 120 days from the date of opening of bids and bid bond shall remain valid for 150 days.
- Special terms & conditions and warranty guaranty attached at annexure 01.

Signature : \_\_\_\_\_  
 Person Name : \_\_\_\_\_  
 Company's Name : \_\_\_\_\_  
 Date : \_\_\_\_\_



STAMP

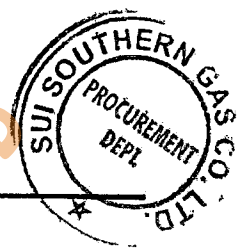

**End of page, any entry beyond this line would be invalid**

Evaluation Criteria and Special Terms and Conditions attached at Annexure:- A

**ANNEXURE - A**

**SSGC/LP/NTPO/PT/2048093**

(Only for Pre-Qualified Vendors)

(By Invoking PPRA Clauses 42(d)(i) & (ii) "Negotiated Tendering" (Vendorized Items))

**1. Evaluation Criteria:**

- a. Order will be placed on lowest Technically/Commercially Compliant bidder(s). Order may be placed on more than one bidder subject to technical/Commercial responsiveness of the bids.
- b. Your offered / quoted price shall be supported with cost break-up of various inputs including material, labor etc. Source of procuring raw material rate shall also be indicated.
- c. Variation in major input material price exceeding 10% may be subject to adjustment. However, Vendors will hold the rates for first 6 months delivery schedule by arranging the raw material on receipt of purchase order from SSGC.
- d. Allocation of order quantity will be decided on the following factors:
  - I. Quoted price.
  - II. Past performance both in delivery & quality.
  - III. Manufacturing capacity of vendor with respect to supply of ordered material to SSGC.
- e. Company may hold discussions with the vendors in order to rationalize the quoted Rates and delivery schedules

**2. Performance Bond :**

- a. 10% Performance Bond is required. (PBG shall be submitted after placement of purchase order).

In case when bidder submit alternate bids, a separate Bid Bond for each bid is required. Otherwise bid will be liable for rejection.

The quoted unit price and corresponding total amount shall be inclusive of all duties and taxes and discounted (if any) except General Sales Tax (GST). Sales Tax will be applicable as per GST act and subsequent amendments of time to time. GST will be reimbursed to manufacturer and importers only subject to production of paid invoice.

Special terms & Conditions and Warranty Guaranty attached at annexure 01.

Bid Validity: 120 days.

Earnest Money (Fixed Bid Bond): PKR 101,300/-

Delivery Schedule: 30,000 Pieces per Month. The delivery shall start within 15 days after receipt of PO. Samples must be provided by the bidders upon request.

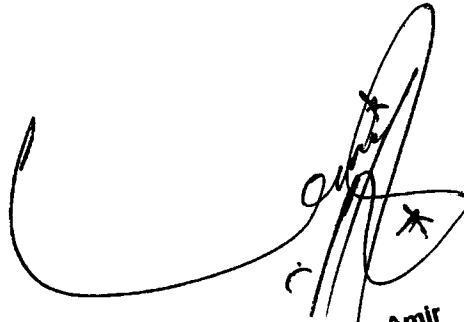

**Muhammad Tahir Amir**  
Deputy Manager (SCM)  
Meter Manufacturing Plant  
Sui Southern Gas Company Limited

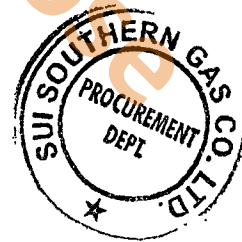

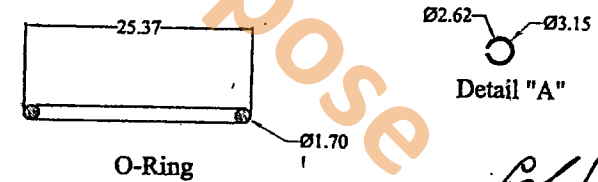
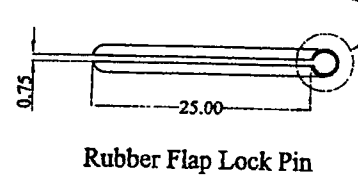
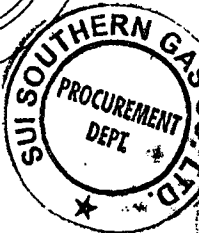
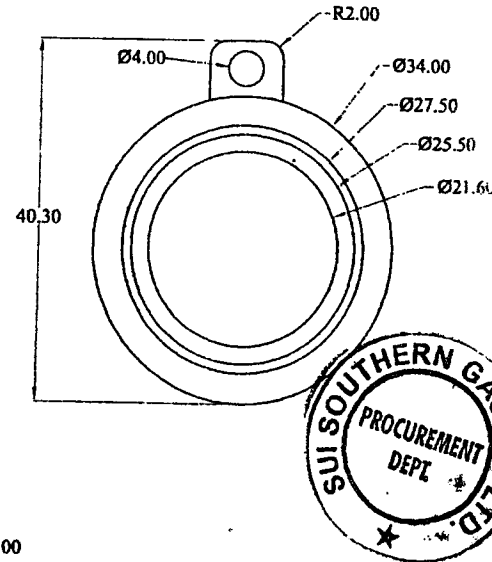
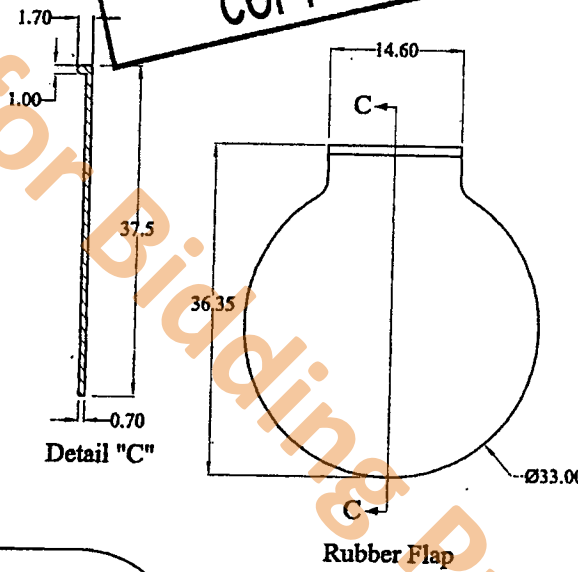
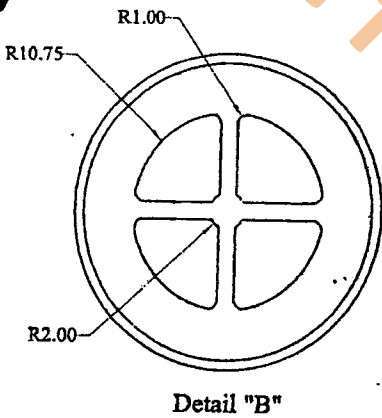
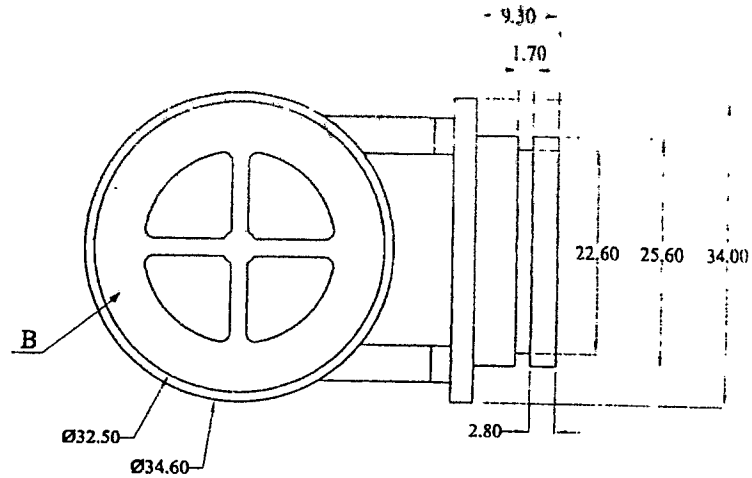
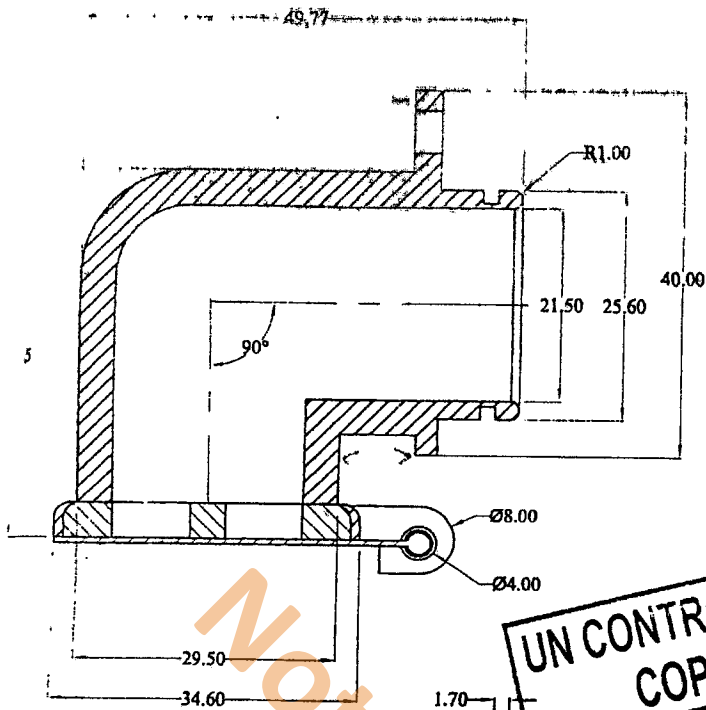

Detail "A"

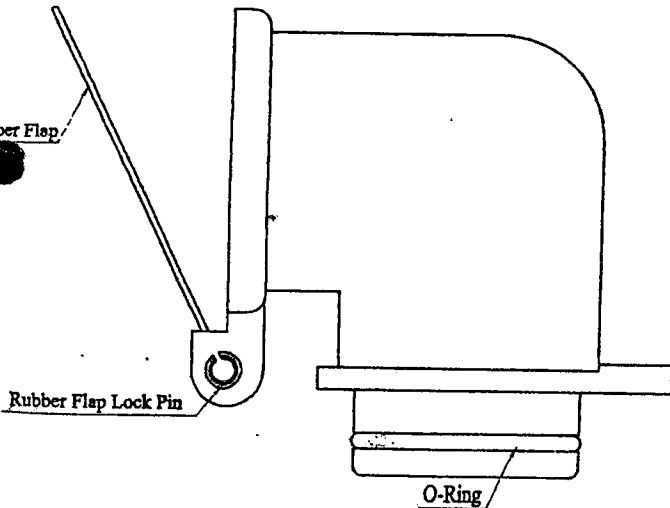

ALL DIMENSIONS ARE IN MILLIMETERS

DATE	DRAWN (NAME)	CHECKED (INITIAL)	REVIEWED & APPROVED (INITIAL)	REVISION
16-01-2020	SHAQOAT HASSAN	<i>[Signature]</i>	<i>[Signature]</i>	AMENDMENT IN DESIGN
		AE (CC)	DCE (SCM/QA)	

<b>SUI SOUTHERN GAS COMPANY LIMITED</b> <b>METER MANUFACTURING PLANT</b>	
<b>TITLE:</b> Metallic Deflector With Plastic Gird Assembly for 3RD Generation G-4 Gas Meter	
<b>MATERIAL:</b> O-Ring & Rubber Flap : NBR Remaining Parts: Polycarbonate	
<b>PROCESSING:</b> --	<b>SURFACE TREATMENT:</b> --
<b>OLD DWG REF:</b> ---	<b>INDEX NO:</b> 51042803
<b>DRAWING NO.:</b> MP-MDPGA-DV355R03	

S. TASAWAR MUSTAFA  
 AGM (MMP)  
 Sui Southern Gas Company Limited

**GENERAL INFORMATION**

DA # \_\_\_\_\_

DATE: \_\_\_\_\_

LOT SUPPLIER: \_\_\_\_\_

LOT QUANTITY: \_\_\_\_\_

SAMPLE SIZE: \_\_\_\_\_

SAMPLE DRAWN BY: \_\_\_\_\_

SAMPLE INSPECTED ON: \_\_\_\_\_

SAMPLE INSPECTED BY: \_\_\_\_\_

(Note: All dimensions are in millimeters)

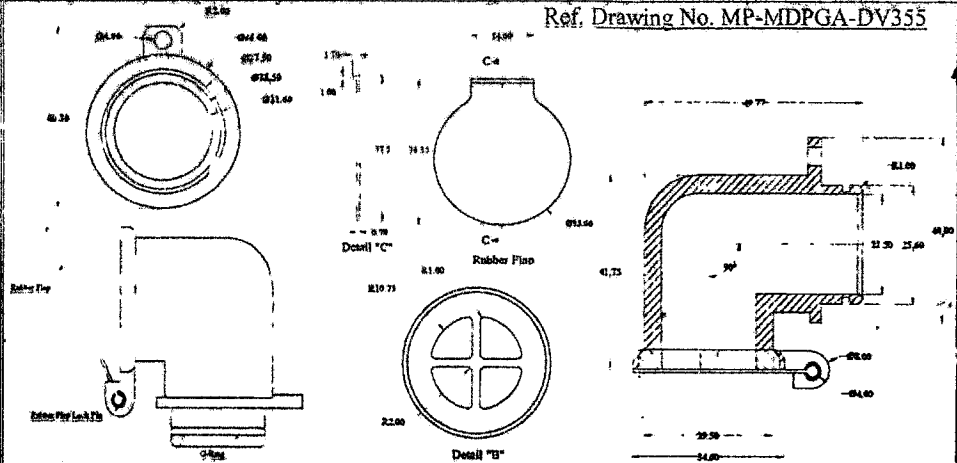

**INSPECTIONS**

<b>VISUAL INSPECTIONS</b>	1. FINISHING OF RUBBER FLAP & PLASTIC GIRD:	5. DESHAPE RUBBER FLAP:
	2. BURR:	6. PROPER FIXED RUBBER FLAP:
	3. EXTRA MATERIAL :	7. LOOSE RUBBER FLAP PIN:
	4. SMOOTH SURFACE OF GIRD :	8. ANY OTHER::

DIMENSIONAL INSPECTION	SR. NO	CRITICAL DIMENSIONS	CLASS BOUNDARIES	OBSERVATIONS	QTY.				
	1.	RUBBER FLAP THICKNESS 0.7 ±0.05	0.55 - 0.59	0.7 - 0.75	<b>UN CONTROLLED COPY</b>				
0.60 - 0.64									
0.65 - 0.69									
0.76 - 0.80									
0.81 - 0.85									
0.86 - 0.90									
2.			STEP DEPTH 9.30 ±0.02			9.15 - 9.19	9.30 ±0.02		
						9.20 - 9.24			
						9.25 - 9.29			
						9.31 - 9.35			
						9.36 - 9.40			
						9.41 - 9.45			
3.			STEP DIA Ø25.60 ±0.02			25.43 - 25.47	Ø25.58 - 25.62		
						25.48 - 25.52			
						25.53 - 25.57			
						25.63 - 25.67			
	25.68 - 25.72								
	25.73 - 25.77								
4.	HEIGHT 49.80 ±0.05	49.60 - 49.64	49.75 to 49.85						
		49.65 - 49.69							
		49.70 - 49.74							
		49.86 - 49.90							
		49.91 - 49.95							
		49.96 - 50.00							

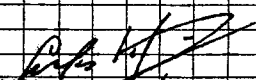
  
**S. TASAWAR MUSTAFA**  
 AGM (MMP)  
 Meter Manufacturing Plant  
 Sui Southern Gas Company Limited





**LOT INSPECTION REPORT**  
**METALLIC DEFLECTOR WITH PLASTIC GIRD**  
**ASSEMBLY FOR 3<sup>RD</sup> GENERATION G-4 GAS METER**

**LOT INSPECTION REPORT**  
**NO: QC-MDPGA-LIRV355R01**  
 Page 2 of 2

5.	TOTAL LENGTH 41.75 ±0.05	41.55 - 41.59		<b>UN CONTROLLED COPY</b>
		41.60 - 41.64		
		41.65 - 41.69		
		41.70 - 41.75		
		40.76 - 41.80		
		41.81 - 41.85		
		40.86 - 40.90		

*[Handwritten signature]*

<b>FUNCTIONAL INSPECTIONS</b>	1. PROPER FIXING WITH TOP CASE:	5. SMOOTHLY MOVEMENT OF RUBBER PIN:
	2. PROPER FITTED RUBBER FLAP:	6. LEAKAGE:
	3. PROPER MOVEMENT OF RUBBER FLAP:	7. ANY OTHER FUALT:
	4. RUBBER FLAP PROPER FIXED WITH RUBBER PIN:	8.

**S. TASAWAR MUSTAFA**  
 AGM (MMF)

DETAIL OF INSPECTOR, INSTRUMENTS & GAUGES USED		CRITERIA FOR ACCEPTANCE OR REJECTION (ON AQL = 1.5) :	CONCLUSION
1. VERNIER CALIPER			
INSPECTED BY: (INSPECTOR Q.C.)	NON CONFORMITIES FOUND:		
SIGNATURE: _____	1. _____ (No.) = _____ %		
NAME: _____	2. _____ (No.) = _____ %		
DATE: _____	3. _____ (No.) = _____ %		
	<b>TOTAL NON CONFORMING PIECES (Nos.) = _____ %</b>		
	OVERALL REMARKS: _____		

Meter Manufacturing Plant  
 CHECKED BY: \_\_\_\_\_  
 Su: Southern Gas Company Limited  
 (IN CHARGE Q.C.)

SIGNATURE: \_\_\_\_\_  
 NAME: \_\_\_\_\_  
 DATE: \_\_\_\_\_

Bidding Purpose

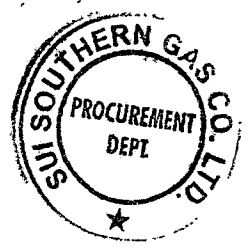

# Technical Evaluation Criteria for Components of Domestic Gas Meters

## New Pre-Qualified Bidder

Bidder shall submit the samples with sample inspection report:

- a. Sample shall be free of any surface defect, burr, flushing, finishing defect or deformation.
- b. Dimensions of samples shall be within the tolerance as per drawings and specifications provided with the tender enquiry.
- c. Samples shall conform to the functional test.

In case of Non-conformance in above criteria, shall result in technical non-responsive of the bid.

## Regular Pre-Qualified Bidder

1. Bidder shall submit the samples with sample inspection report:

- a. Sample shall be free of any surface defect, burr, flushing, finishing defect or deformation.
- b. Dimensions of samples shall be within the tolerance as per drawings and specifications provided with the tender enquiry.
- c. Samples shall conform to the functional test.

*S. Tasawar Mustafa*  
**S. TASAWAR MUSTAFA**  
AGM (MMP)  
Meter Manufacturing Plant  
Sui Southern Gas Company Limited

2. Supplies against last Purchase Order shall be completed as per given delivery schedule.
3. Supplies against last Purchase Order shall be completed without any lot rejection.

In case of Non-conformance in above criteria, may result in technical non-responsive of the bid.

SSGC has the right to conduct process audit of the supplier's manufacturing facility with or without intimation.

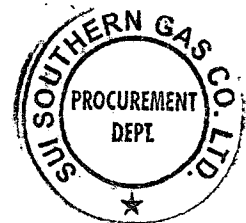

28.

# Checklist for Bidders

Enquiry No. : \_\_\_\_\_ Opening Date : \_\_\_\_\_ Time : \_\_\_\_\_  
 M/s. \_\_\_\_\_ Phone No. \_\_\_\_\_

Please ensure before submitting the bid, that following information / documents have been submitted / provided along your bid check { } appropriate bod.

Sr. #	Details of required information / documents	Yes	No
1.	Fixed Bid Bond as specified is enclosed.		
2.	Original Technical literature is enclosed, if any		
3.	Any change in your current address, phone, fax no. & email etc are intimated		
4.	Bid validity as specified is mentioned.		
5.	Delivery period has been specified.		
6.	All correction/cutting/overwriting are signed & stamped.		
7.	Sample (if necessary) is enclosed.		
8.	Each & Every Page of the bidding documents shall be signed and stamped by the bidder.		
9.	Original Bid + One copy is submitted.		
10.	Form-X & Bid Securing Declaration duly signed & stamped		

Note: Non-availability of the above information/documents, or incomplete/incorrect statement on this checklist may result in rejection of the bid at / after the bid opening.

As per SRC296(I)/2023 dated 08th March 2023 "E-Pak Procurement Regulations, 2023" all bidders are advised to register in e-Pak Acquisition and Disposal System (EPADS).

Bidders Authorized Representative





**Tender Enquiry No. SSGC/LP/  
Special Conditions of Tender Document**

**Note:** In case of any conflict between Special Conditions of Tender Document and any other terms & conditions, the Special Conditions of Tender Document will govern / prevail.

**1. Warranty / Guarantee Coverage**

- i) The successful bidder / supplier guarantee that the goods supplied against above tender enquiry are in all respect in accordance with the tender specifications & Purchase Order and that material used are in accordance with the latest approved standards and are of good workmanship / quality. Any item or part of item if found to be substandard or not meeting the specified criteria as per inspection carried out at stores. Then in such as event the Supplier / bidder hereby warrants and undertake to replace the same on Duty Delivery Paid (DDP) basis (INCOTERMS 2010) i.e. Free of all cost including but not limited to transportation. Taxes and levies. In case successful bidder / supplier failure to replace the defective item / remove the defect(s) free of cost within the period specified by the Purchaser, the successful bidder / supplier will refund the relevant cost including all other expenses incurred by the purchaser in this regard.
- ii) The successful bidder / supplier must confirm that the warranty for non-consumable items will remain valid for 18 months and for consumable items (i.e. Chemical, Battery etc.) will remain valid for 6 months after the goods have been successfully delivered or commissioned.
- iii) It is mandatory that the successful bidder / supplier will submit the attached undertaking at Annex-1, duly filled, signed & stamped.
- iv) In case where performance guarantee is not applicable. the supplier shall confirm that all supplied goods under the contract / purchase order are new, unused, of most recent or current models and incorporate all recent improvements in design and goods unless and otherwise provided in the contract / purchase order.
- v) The Warranty Undertaking being provided by the successful bidder is required to be submitted at least on Rs.200/- Non-judicial Stamp paper and should be duly notarized / attested.
- vi) In case of Supply, Installation, Testing & Commissioning, since all these activities are inter-related to each other. therefore, the payment of supplies will be released after successful installation, Testing & Commissioning.

**2. Bid Security:**

- a) Bid bond submission (2%) of the bid amount as mentioned in the clause 9 of General Terms & Conditions, to be treated as null & void, however, other contents of clause 9 will remain unchanged. The submission of fixed amount of Bid security is appearing in the Schedule of Requirement/Bid Form.
- b) All the bidders are advised to furnish fixed bid security amount appearing in Schedule of Requirement/Bid Form, failing which their bid will be rejected.
- c) The submission of fixed amount of bid security is also mandatory for all the bids valuing Rs.500,000/- or less.
- d) The word lowest bidder or the lowest evaluated bid has been substituted to read as most advantageous bid.
- e) Sub-clause 9.2 of the General Terms & Conditions to be treated as null & void, however, other contents of clause 9 will remain unchanged.

**3. Method For Submission of Bid Bond (Under Single Stage Two Envelope Bidding Procedure):**

In case of Single Stage Two Envelope Tenders the fixed bid bond as per clause#09 of General Terms & Conditions to be placed in the Technical Proposal. However, if the bid bond is placed in the financial proposal will also be considered. Without submission of bid bond (either in Technical proposal or financial proposal) the bid will be rejected.

**4. Bid Validity:**

All offers shall remain valid up to 120 days from the date of opening of bids and bid bond shall remain valid for 150 days.

**5. Declaration / Integrity Pact / Certification:** It is required to be submitted by the Successful Bidder on their letterheads after issuance of Purchase Order (PO) or Letter of Intent (LOI), for the value of Rs.10,000,000/- (Ten Million) or above. ANNEXURE-C is a mandatory requirement for successful bidder.

**6. Stamp Duty:**

The successful Bidder shall provide the copy of challan and revenue stamp, of value at the rate of twenty five (25) paisa per every hundred Rupees or part thereof of the amount of the purchase order, or at the prevailing rate as specified by the Government of Province of Sindh." Further as per Government of Sindh Board of Revenue notification NO.CIS/SWB/BOR/R&T-17/2022-808 dated 08-06-2022 all judicial and non-judicial stamp paper of the denomination of rupee five hundred and above shall be exclusively on e-stamp.

**7. Cancellation of Purchase Order**

In case the supplier fails to deliver the material within the specified delivery schedule as given in Purchase order (P.O.) and maximum upto 120 days after the expiry of the specified delivery schedule as per Purchase Order, the Purchase Order will be treated automatically as cancelled at supplier's sole risk & cost. However, for the sake of



clarity liquidated damages (Clause-27 of General Terms Conditions) and Default by Supplier (Clause-28 of General Terms Conditions) will be treated as given in the General Terms & Conditions of the tender documents

**8. Correct Postal Address.**

Bidder are essentially required to provide correct and latest postal, e-mail & web addresses, Phone/cell/fax numbers at the time of purchase of tender documents for effective and timely communication, failing which in event of any non-delivery of information /communication the procuring agency will not be held responsible and bid will be considered as non-responsive.

9. "In case the local agent requires to offer bid from more than one principal / Manufacturers, it is mandatory to purchase separate tender document for each principal / Manufacturer, failing which the bid submitted with the original tender document will only be accepted and the bid with photocopy of tender document will be rejected".

10 "Original counter slip of token which is issued with original tender document to be attached on the TOP of envelope at the time of bid submission".

11. The Successful Contractor(s) / Consultant(s) shall submit a copy of Professional Tax Certificate with their invoice / Bills failing which the payment will not be released.

**12. Blacklisting Mechanism of Suppliers and Contractors and their Local Agent:**

*Black listing mechanism is attached separately in the tender documents which will become an integral part of Tender Documents and now be followed / enforced in true letter & spirit and supersede the Black listing terms as mentioned in the General Terms & Conditions.*

**13. Bid Bond & PBG (Performance Bank Guarantee) for Proprietary Tenders**

*In case of proprietary Tenders, the Bid Bond & Performance Bank Guarantee (PBG) are not required / Applicable.*

14. Any Bidder who change / amend the BOQ or Price Schedule (description, Quantity, UOM etc.) will render the bid as conditional bid and will be liable for rejection.

15. Clause 14.1 of General Terms & Conditions is meant for vendorized items processed through negotiated tendering clauses.

16. For open competitive bidding if the most advantageous bidder is new local manufacturer, 10% trial order will be placed and remaining 90% order will be awarded to the next most advantageous bidder at their own quoted rates.

17. SSGC will not pay invoices if they are turned in after 6 months of work completion / material delivered.

18. It is mandatory for the bidders to follow all the terms and conditions given in the tender documents without any addition / deletion / amendment and submit the bid accordingly. Therefore, in this context, the bidders are requested not to give their own terms and conditions as it tantamount towards the conditional bid. Otherwise their terms and conditions will not be considered and the Purchase Order / Contract will be awarded based on only as per SSGC tender terms and conditions.

19. The bidders/contractors are required to provide their only one Bank Account number (IBAN number) on the 'FORM-X' attached duly signed & stamped as one time information, which shall be firm (not changeable) for all the future payment transactions.

**20. Payment:**

The supplier after delivery of goods and its acceptance shall submit invoice to Finance Department of the Company, containing following information i.e.

(a) Purchase order No. & date

(b) Items

(c) Quantity

(d) Price

(e) Invoice value

(f) Point of delivery

(g) Delivery challan indicating delivery date, etc.

(h) Supplier(s) are required to submit signed and stamp acknowledgement slip, Sales Tax return, Annex "C" & Annex "I" (whichever applicable) in which Sales Tax (of relevant Sales Tax invoice) is paid.

Payment will be made within 30 days of completion of stated requirements.

21. **Joint Ventures:** In the event that the bidder is bidding as a Joint Venture, the Company will require the joint venture agreement duly executed by the parties to the Joint Venture to be submitted with the bid. The joint venture parties shall also furnish an undertaking to be jointly and severally liable for all liabilities arising out of obligation under the Purchase Order / Contract. The Joint Venture agreement of the parties must specify share of each partner and name of the lead partner along with their registration with the FBR, SST and BST as the case may be failure to specify these two narrations the joint venture agreement will not be entertained.

22. Bank Guarantee (Bid Bond Guarantee/Performance Bank Guarantee) will be made on Non-Judicial stamp paper at the prevailing rate as specified by the respective Provinces. Further the bidder/contractor submitting the Bid Bond guarantee/Performance Bond guarantee being prepared by the State Bank's schedule banks should ensure that there should be no



deletion/insertion/alteration/modification of any terms in the Bid Bond/PBG guarantee format as given in the tender document or else bid will be liable for rejection.

23. In case the insurance policy submitted by the contractor is expired during the execution of job, it is the responsibility of the user department to coordinate with the contractor to get it renewed/updated till the period the job is completed/commissioned.  
In case the job is not completed within the given time as per tender terms and the insurance policy submitted by the contractor expires, the contractor is liable to get this insurance policy renewed / updated immediately till the period of the job is completed / commissioned as per tender terms failing which the contractor will be responsible for any loss to SSGC.
24. Bidders can quote their rates on both i.e. Schedule of Requirement/Bid Form as well as Bill of Quantity (BoQ).
25. Company reserve the right to award the Purchase Order /LOI to the most advantageous bidder.
26. As per SRO 592(I)/2022 of PPRA Regulations, for Procurement Contracts/Purchase Orders worth of Rs. 50 million and above, bidders/contractors are required to submit the Beneficial Owner's Information for Public Procurement Contracts/Purchase Orders (Annexure-I).
27. **Fixed Bid Security – Alternative Bid**  
A bidder cannot submit two bids/offers with a single fixed bid security/pay order. However, the alternative bids/offers with separate fixed bid security/pay order can be accepted, failing which the bids will be liable for rejection. In case the bidder quote different make/brands/model that will also be considered as an Alternative bid/offer and require to submit separate Bid bond for each make/brand/model.
28. Bidder will be blacklisted and henceforth cross debarred for participating in respective category of Public Procurement proceedings for a period of (not more than) six months, if fail to abide with a bid securing declaration (which is an integral part of tender document), however, without indulging in corrupt and fraudulent practices, if in breach of obligation(s) under the Bid conditions:  
a) The bidder have withdrawn or modified their bid during the period of bid validity as specified in the tender terms.  
b) Having been notified of the acceptance of bid by procuring agency during the period of bid validity (i) failure to sign the contract or accept purchase order (ii) fail or refuse to furnish the performance security or to comply with any other condition as mentioned in the tender document.
29. The term "Call Deposit Receipt" mentioned in clause # 09 (Bid Bond) of General Terms & Conditions and in clause # 02 (Bid Bond) of Additional Terms for Tenders on F.O.B & C&F basis be treated as null & void.
30. Wherever the "Rate Only" is mentioned (either on BOQ or anywhere in tender documents) the same shall only be applicable not exceeding 15% of the original procurement for the same items as given in the BOQ for package basis. In case the requirement is on item wise basis (not package basis) then not exceeding 15% of the original Procurement for the same items (on item wise basis) as given in the BOQ.
31. Lots: In case when the tender is floated on LOT basis, following clauses to be applied:  
a) The bidder(s) are essentially / mandatorily required to submit fixed bid bond as mentioned in the bid form/BOQ/Invitation to Bid. Separate fixed bid bond to be submitted against each individual LOT and its validity to be 150 days at the time of opening of technical proposal.  
b) Evaluation for each LOT will be carried out separately. Each LOT will be awarded separately.
32. Subsequent to the issuance of Purchase Order/LOI, successful bidder has to submit 10% Performance Bank Guarantee of the Purchase Order/LOI value unless & until specified in the Tender Documents. Clause# 16.1.5 mentioned in General Terms & Conditions to be treated as null & void.
33. Redressal of Grievances And Settlement of Disputes:
- Any bidder feeling aggrieved by any act of the procuring agency after the submission of his bid may lodge a written complaint concerning his grievances within seven days of announcement of the technical evaluation report and five days after issuance of final evaluation report.
  - In case, the complaint is filed against the technical evaluation report, the GRC shall suspend the procurement proceedings.



- In case, the complaint is filed after the issuance of final evaluation report, the complainant cannot raise any objection on technical evaluation of the report. Provided that the complainant may raise the objection on any part of the final evaluation report in case where single stage single envelope bidding procedure is adopted.

34. The sub clauses 33.2, 33.4 & 33.5 of clause 33 of General Terms & Conditions to be treated as null & void.



Not for Bidding Purpose

# Form of Bid-Securing Declaration

[The Bidder shall fill in this Form in accordance with the instructions indicated.]

Date: [date (as day, month and year)]

Alternative No.: [insert identification No if this is a Bid for an alternative] No.: [number of Bidding process]

To: [complete name of Procuring Agency]

We, the undersigned, declare that

We understand that, according to your conditions, Bids must be supported by a Bid-Securing Declaration.

We accept that we will be blacklisted and henceforth cross debarred for participating in respective category of public procurement proceedings for a period of (not more than) six months, if fail to abide with a bid securing declaration, however without indulging in corrupt and fraudulent practices, if we are in breach of our obligation(s) under the Bid conditions, because we:

(a) have withdrawn our Bid during the period of Bid validity specified in the Letter of Bid; or

(b) having been notified of the acceptance of our Bid by the Procuring Agency during the period of Bid validity, (i) fail or refuse to sign the Contract or (ii) fail or refuse to furnish the Performance Security (or guarantee), if required, in accordance with the ITB.

We understand this Bid Securing Declaration shall expire if we are not the successful Bidder, upon the earlier of (i) our receipt of your notification to us of the name of the successful Bidder; or (ii) twenty-eight days after the expiration of our Bid.

Name of the Bidder: \_\_\_\_\_

Name of the person duly authorized to sign the Bid on behalf of the Bidder: \_\_\_\_\_

Title of this person signing the Bid: \_\_\_\_\_

Signature of the person named above: \_\_\_\_\_

Date signed: \_\_\_\_\_

In the case of the Bid submitted by joint venture specify the name of the Joint Venture as Bidder

Person signing the Bid shall have the power of attorney given by the Bidder attached to the Bid

[Note: in case of a Joint Venture, the Bid-Securing Declaration must be in the name of all members to the joint venture that submits the Bid.]

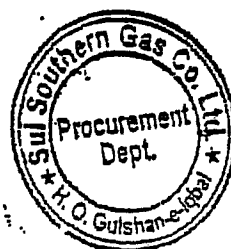

Supplier code: \_\_\_\_\_

**FORM-X**

**Bank account details form for all Beneficiaries**

**(Mandatory requirement for Digital Online Banking)**

As per FBR Regulations ref # C.No.4 (24) IT-Budget/2021-142150-R dated 23<sup>rd</sup> Sept'2021 to make the payment online w.e.f. 01-11-2021. All beneficiaries are required to fill in the below details, which is mandatory:

Name of Firm: \_\_\_\_\_

Address of Firm: \_\_\_\_\_  
\_\_\_\_\_

CNIC #: \_\_\_\_\_

NTN #: \_\_\_\_\_

Bank Name: \_\_\_\_\_

Bank A/C Title name: \_\_\_\_\_

Branch code: \_\_\_\_\_

Bank A/c #: \_\_\_\_\_ (16 Digits)

Bank IBAN #: \_\_\_\_\_ (24 Digits)

Information already submitted.

**Note: Please be attached copy of Cheque / Account Maintenance Certificate.(Mandatory)**

\_\_\_\_\_  
Authorized Sign & Stamp

Date: \_\_\_\_\_

**Note: All payments transactions will be made on above mentioned Account details. This is only a one time information to be provided by the all beneficiaries. Incase if the above detail has already submitted, please tick the box above "Information already submitted" and also ensure Form-X is duly signed & stamped.**

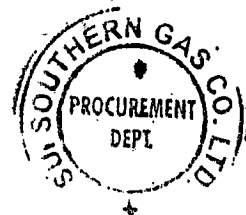

ANNEXURE: I

Declaration of Ultimate Beneficial Owners Information for Public Procurement Contracts.

1. Name
2. Father's Name/Spouse's Name
3. CNIC / NICOP/Passport No.
4. Nationality
5. Residential address
6. Email address
7. Date on which shareholding, control or interest acquired in the business.
8. In case of indirect shareholding, control or interest being exercised through intermediary companies, entities or other legal persons or legal arrangements in the chain of ownership or control, following additional particulars to be provided:

1	2	3	4	5	6	7	8	9	10
Name	Legal form (Company/Limited Liability Partnership /Association of Persons/Single Member Company/Partnership Firm/Trusted/Any other Individual, Body Corporate (to be Specified)	Date of Incorporation / Registration	Name of Registering Authority	Business Address	Country	Email Address	Percentage of shareholding, control or interest of BO in the Legal Person or Legal Arrangement	Percentage of shareholding, Control or Interest of Legal Person or Legal Arrangement in the Company	Identity of Natural Person who Ultimately owns or Controls the Legal Person or Arrangement

9. Information about the Board of Directors (details shall be provided regarding number of shares in the capital of the company as set opposite respective names).







## Sui Southern Gas Company Limited (SSGCL)

## Contents

## Part- A

Section - 1	General Terms & Conditions	Included
Section - 1A	Additional Terms & conditions for FOB /C&F	Included
Section - 2	Special Terms & Conditions	Included /Not required
Annexure-A	Format of Bid Bond Bank Guarantee	Included
Annexure-B	Format of Performance Bank Guarantee	Included
Annexure-C	Declaration by Supplier	Included /Not required

## Part- B

Section - 3	Bid Form (Schedule of requirement)	Included
Section - 4	Specifications/Drawing (if applicable)	Included /Not required



SSGC

SUI SOUTHERN GAS COMPANY LIMITED  
Procurement Department

M/s. \_\_\_\_\_  
\_\_\_\_\_  
\_\_\_\_\_

Tender Enquiry No. \_\_\_\_\_

INVITATION TO BID

Sui Southern Gas Company Limited (SSGCL) has pleasure in extending you an invitation, to submit bid for the subject material according to Terms and Conditions specified in the attached Tender Document. Please read following instructions before submission of bid:

1. Bids are to be submitted in sealed envelope provided with the tender, indicating Tender Enquiry Number & its opening date and time on the face of the envelope.
2. Bid Bond @ 2% of the total FOR / FOB value shall be enclosed with the bid without which bid will be rejected and returned to bidder unannounced. The Bid Bond shall remain valid till the last date of the month in which it is expiring.
3. In case the bid opening date falls on a holiday or due to some unavoidable circumstances, it is not possible to open on scheduled date, it will be opened on next working day at the same time and at the same venue.
4. The bidder shall bear all expenses associated with the preparation and delivery of its bid/sample and the Company will in no case be liable in this respect.
5. Prospective bidder requiring any information or clarification of the tender may notify the same by fax or at the mailing address. The Company will respond to any request for explanation or clarification, if received within reasonable time prior to submission of bids.
6. The Company reserves the right to cancel, add, delete or amend tendered items/quantities/any part of the tender during the bidding period without assigning any reason. However, bidders shall be informed about it prior to bid opening/process.
7. The Company reserves the right to accept or reject any bid or part of a bid or to annul the bidding process and reject all bids at any time prior to award of contract/purchase order without thereby incurring any liability to the affected bidder(s).
8. In case of Single stage two (02) envelope bidding procedure (if mentioned in press advertisement & Tender document), sealed technical offer & sealed bid shall be submitted in separate envelopes Bid Bond will be enclosed with "commercial" bid. "Technical Proposal" and "Financial Proposal" is to be mentioned on the top of the envelope. Technical offers will be opened and evaluated first. Financial offers of only technically compliant bidders will be opened at a later intimated date in presence of bidder's representatives. Financial proposal of technically non-compliant bidders will be returned un-opened along with their bid bond.
9. For Tenders invited on F.O.B/C&F basis, conditions as mentioned in Section-1A will also apply.
10. The Company will appreciate confirmation by fax No 92-21-99231583 or email at mmte@ssgc.com.pk or to DGM (Procurement) of your intention to submit the bid and if not interested in submission of bid, it will be appreciated if it is intimated through fax or email with mentioning of reasons.
11. Bids are required to be submitted at:

Tender Room, CRD Building, Head Office Complex, Sir Shah Suleman Road Gulshan-e-Iqbal, Karachi Pakistan. Ph. 0092-21-99021024, 0092-21-99021223, 0092-21-99021279, 0092-21-99013074, Fax # 0092-21-99231583, Email: mmte@ssgc.com.pk

Hope and look forward for your valued participation.

Thanking you

Yours sincerely

\_\_\_\_\_  
General Manager (Procurement)



## General Terms &amp; Conditions

## 1. Submission of bids:

- 1.1. Bids are to be submitted in sealed envelope provided with the tender (in such a manner that contents are fully kept enclosed and cannot be seen until opened) indicating tender enquiry number, its opening date and time on the top of the envelope. Envelopes shall be addressed to General Manager (Procurement Department) on the address provided on "invitation to bid". Envelope shall indicate the name and address of the bidder for returning the bid in case it is declared late or submitted without bid bond.
- 1.2. Sealed bids (as above) shall be mailed/submitted/dropped in tender box placed at Tender Room, CRD Building, SSGC Head Office. Bids are to be delivered on or before closing time after which bid will not be entertained. In case bid is sent through courier, the same shall be delivered at least half an hour before scheduled opening time.
- 1.3. The Company may at its discretion extend the closing date for the submission of bids, in which case all rights and obligations of the purchaser and bidders previously subject to the closing date will thereafter be subject to the date extended. However, any request for extension received from prospective bidders less than one week prior to bid opening date may not be entertained. In case of extension in bid opening date, the same will be advertised in press and simultaneously shall be intimated to prospective bidder who had purchased the tender documents.
- 1.4. The bid shall contain no interlineations, erasures or overwriting except as necessary to correct the errors made by the bidder, in case of any correction etc. it shall be signed and stamped by the person signing the bid.
- 1.5. The quoted price shall be inclusive of all duties/taxes except GST, which is to be mentioned separately. The supplier shall declare (if applicable) regarding non-applicability of GST for which documentary evidence shall be enclosed or could be produced upon demand.
- 1.6. Rates shall be item-wise, as given in price schedule/schedule of requirement/Bid Form unless otherwise specified.
- 1.7. Bidder is responsible for timely delivery of bids at location specified 1.2 above. Company will not be responsible for misplacement/ tampering/non-attendance/delay or any other incident in case the bid is not delivered at the designated place & time.
- 1.8. Any bid received late after the closing date and time, will be rejected and returned unopened.
- 1.9. The quotation shall only be acceptable on/as per Bid Form. In case for foreign tender when Local Agent submits bid on behalf of different bidders, a separate Bid Bond for each Bid is required. Likewise for tender when bidder submit alternative bids a separate bid bond for each bid is required or else bid will be liable for rejection.
- 1.10. Deviation from tender terms and conditions is not allowed. However, in unavoidable circumstances, these shall be mentioned at the bottom of "Section 3: Bid Form" deviation on any other page will not be entertained.
- 1.11. Discount offered (if any) shall be mentioned on the "bid form" only.
- 1.12. The bidder(s) or their authorized representative shall put his full signature with stamp & date on each page of tender document as well as enclosure vis-a-vis drawings, specifications etc. Any correction, overwriting shall be duly signed & stamped.
- 1.13. The bid is to be completed and returned to the Company in accordance with, General terms & conditions. General terms & conditions duly signed & stamped (as a token of acceptance) shall be submitted along with Bid Form (Price schedule) duly completed as per requirement. However, specifications/drawing is to be retained by bidder for their future references.

## 2. Eligible Countries / bidders:

The invitation for bids is open to all manufacturers/suppliers/stockiest/dealers/pre-qualified bidders but is not applicable to those countries where inter trade protocols with Pakistan do not exist or those countries from where imports are not allowed by Government of Pakistan.

## 3. Qualification/Disqualification of Suppliers:

The Company, at any stage ~~may~~ **Please Follow the Attached Black Listing Mechanism**, having credible reasons for or prima facie evidence of any defect in supplier's ~~performance~~ **Please Follow the Attached Black Listing Mechanism**, may require the suppliers or contractors to provide information regarding their professional, technical, financial, legal or managerial competence.

**Please Follow the Attached  
Black Listing Mechanism**



whether already pre-qualified or ~~disqualified~~ <sup>disqualified</sup> ~~Company shall~~ <sup>disqualify</sup> a supplier or contractor if it finds, at any time that the information regarding ~~the supplier or contractor~~ <sup>the supplier or contractor</sup> was false and materially inaccurate or incomplete.

4. **Joint Ventures:**

In the event that the successful bidder is a joint venture (formation of two or more companies), the Company will require an undertaking on judicial stamp paper that the parties to the joint venture accept joint and several liabilities for all obligations under the purchase order/contract.

5. **Clarification of tender documents:**

Prospective bidders requiring any further information or clarification of the tender documents may notify, the Company in writing or by fax or at the Company's mailing address indicated in the "invitation to bids". The Company will respond in writing to any request for information or clarification of the tender documents, if received five working days prior to closing date for the submission of bids prescribed by the Company. The Company response (including an explanation of the query) will be sent in writing or by fax/e-mail to all prospective bidders who have purchased the tender documents. Verbal instructions/reference will not be acceptable.

6. **Modification and withdrawal of bid:**

- 6.1 The bidder may modify or withdraw its bid after the bid submission, provided the written notice of the modification or withdrawal is received by the Company prior to the deadline prescribed for submission of bid. After the bids/quotations are opened, no bidder shall be allowed to revise, propose or request any change in the bid.
- 6.2 The bidder's modification or withdrawal notice shall be sealed and addressed to GM (P). A withdrawal notice may be sent by fax followed by a signed copy.
- 6.3 Bids once opened cannot be withdrawn during validity period.

7. **Bid validity:**

All offers shall remain valid up to 90 days (120 days in case of Two Envelope bidding procedure) from the date of opening of bids, until any further extension agreed by the bidder. If the bidder agrees for extending bid validity the bid bond shall also be extended accordingly. A bidder giving extension to his bid validity will not be required or permitted to modify his bid. If there will be any query/clarification or extension request asked by the Company, the bidder should reply the same within 7 days after receipt of the same and if bidder takes more than 7 days the delay in reply will be added to their bid validity period.

8. **Rate Escalation:**

8.1 **All items except line-pipe:**

Quoted prices shall remain valid, firm, irrevocable and fixed till the fulfillment of obligations by the bidder and will not be subject to escalation / change on any account.

8.2 **Line-pipe only:**

- 8.2.1 Bidders are essentially required to submit detailed breakdown of rates indicating per ton price of:
  - a) H.R. Coil.
  - b) All other charges (including wastage, transportation, conversion cost etc).

- 8.2.2 Rate / price offered by the bidders shall be firm and irrevocable. However bidder offering pipe manufactured from Pakistan Steel Mills (PSM) HR coil are required to submit certified documentary evidence of HR coil rates. Adjustment in line-pipe rates (from the bid opening date till the currency of order) due to change in rate of HR coil manufactured by PSM is admissible to the extent of raw material cost without wastage. The bidders are required to submit certified documentary evidence of HR coil rates published by PSM, at the time of submission of bids. SSGC may verify the document / rates from PSM.

- 8.2.3 The variation clause however shall not be applicable on line-pipe quantities which were delivered within 20 days of the announcement of the variation (both days inclusive) in price of HR coil by PSM.



8.2.4 The variation clause also shall not be applicable on the line pipe quantities delivered after the specified delivery schedule (total or monthly consignment wise)

8.2.5 No escalation is applicable on line pipe manufactured from imported HR coil.

9. **Bid bond (earnest money):**

Bid bond equivalent to two percent (2%) of the total offer value, in favor of Sui Southern Gas Company Ltd. shall accompany the bid if bid value is above Rs.500,000 in the form of pay order, demand draft, call deposit receipt or a bank guarantee (specimen of bank guarantee is attached at Annexure-A), issued by a scheduled bank in Pakistan. The bid bond shall remain valid for 120 days (150 days in case of Two Envelope bidding procedure) unless specified otherwise. The bid bond shall be returned/refunded to the unsuccessful bidders while the bid bond of the successful bidder shall be retained, till submission of Performance bond (if applicable). Bids without bid bond will not be considered. In case the order value is less than Rs: 500,000 the bid bond in lieu of performance bond will be retained till fulfillment of obligations by the supplier. However, in either case the bidder is responsible to arrange the extension the bid bond validity as per requirement. If bid bond submitted by the supplier is more than 2% of ordered value, it may be replaced with appropriate value. If order value is less than Rs. 500,000, the bid bond will be returned along with the order. Bid bonds of non-compliant bidders may be released during evaluation process. The bid bond may be forfeited if a bidder withdraws the bid during validity period specified by the bidder or if successful bidder fails to:

- Accept purchase order,
- Furnish performance guarantee in accordance with clause 16 of Section 1,
- Supply material as per requirement and delivery schedule.

9.1 In the event of bid bond validity following short of the prescribed period of 120 or 150 days as the case may be either (i) due to extension in the bid submission date or (ii) where so required by the procuring agency, then in such an event it shall be mandatory on the bidder to extend the bid bond validity upto 120/150 days within 30 days of the opening of technical proposal / bid, and / or where so required by the procuring agency.

9.2 In the event of the bid security amount deposited / furnished by the bidder falls short by 10% of the requisite Bid security amount. The procuring agency keeping in view the nature of the procurement may consider and allow the bidder to deposit / furnish the balance 10% amount, provided the bidder does so within 15 days of the opening of the bid. Notwithstanding that all other terms & conditions have been fully complied with.

10. **Opening of bids:**

Bids will be opened in presence of bidders or their authorized agents at the address provided on "invitation to bids". The bidder's representatives who are present shall sign the bid opening sheet (attendance sheet) to mark their attendance/witness. Commercial contents of bids will be announced/recorded in bid opening sheet.

11. **Preliminary Examination of bids:**

- 11.1 The Company will examine the bids to determine their completion, computational errors, provision of guarantees, authorized signature and other related matters.
- 11.2 Arithmetic errors will be rectified on the following basis. Discrepancy between unit price and the total price obtained by multiplying the unit price and quantity, the unit price shall prevail and the total price will be corrected. Discrepancy between total bid amount and the sum of total prices, the total prices shall prevail and the total bid amount will be corrected.
- 11.3 Prior to a composed evaluation, the Company will determine the substantial responsiveness of each bid to the bidding documents. In Company's opinion a substantially responsive bid is the one which conforms to all the terms and conditions of the bidding documents without any material deviation.
- 11.4 Bid determined as not substantially responsive will be rejected by the Company and cannot subsequently be made responsive by the bidder through correction of the non-conformity.

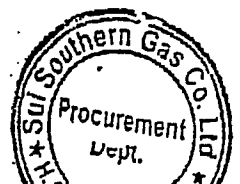

12. **Clarification of submitted bids:**

To assist in the examination, evaluation and comparison of bids, the Company may at its discretion inquire any clarification from bidder about their bid. All responses by bidders shall be provided in writing and no change in the price or substance of the bid shall be sought, offered or permitted.

13. **Technical Literature & Samples.**

The Bidder(s) shall submit the following.

13.1 Samples (if applicable/required)

13.2 Original or legible copy of technical literature/performance characteristics

13.3 Test Certificates (if applicable/required)

13.4 Documentary evidence for legal import in case of imported material. (At the time of delivery when quoted on FOR basis)

13.5 In case of pipeline operation material bidders must also attach a "proof from supplier/manufacturer, that goods offered have been used successfully on a high pressure natural gas pipeline elsewhere under tropical climatic conditions.

13.6 **Specification Compliance Sheet:**

Company requires a clause-by-clause commentary on the Specifications, demonstrating the materials responsiveness to those specifications or a statement of deviations and exceptions to the provisions of the specifications, if so required/desired. For purposes of the commentary to be furnished pursuant to above, the bidder shall note that standards for workmanship, material and equipment and references to brand names or catalogue numbers, designated by the Company in the specifications are intended to be descriptive only and not restrictive. The bidder may substitute other authoritative standards, brand names and/or catalogue numbers in its bid provided which demonstrates to the Company's satisfaction that the substitutes are equivalent or superior to those designated in the specifications by the Company.

Bid which does not possess above documents, certificates etc., may be considered technically Non-compliant.

13.7 The offer shall be accompanied with all technical data/documents/certifications as required under the tender specifications. Evaluation shall be carried out on the basis of data/ documents/certifications submitted with the bid. No clarification, additional information may be sought / accepted after bid opening.

13.8 **Deviation to technical specifications:**

The bidder shall fill the "technical compliance sheet" and mention offered specifications along with reference to its technical brochure/literature (page/clause No.etc). Statement such as "Compliant" or "Confirmed" is not acceptable. Deviation to tender terms and technical specification is not acceptable. However, if bidder feels to mention minor deviation, the same shall be referred categorically on the "Bid Form" as well as on the technical compliance sheet stating reference of its technical data sheet/brochure. In case of insufficient information, data or documents, the Company is not liable to seek clarification and the bid may be determined non-compliant on provided information.

14. **Award/Evaluation Criteria:**

14.1 In case of locally manufactured items e.g. service line material & meter components, manufactured by local vendors, the lowest bidder will be awarded maximum quantity as per his declared capacity and past performance in respect of delivery and quality. New vendors / manufacturers shall also be considered for placement of a purchase order up to a maximum of 10% of the tender quantity if their submitted sample has been tested and approved and provided they have quoted lowest price or agree to accept the order on lowest received price.

14.2 Generally for other items other than above, ordering shall be based on technical compliance and lowest quoted price. Supplies may be subject to pre shipment inspection and post qualification by a third party in case of foreign material. If required during the process of manufacturing and / or inspection, SSGCL representative may visit the manufacturer facility to witness the manufacturing / inspection process.

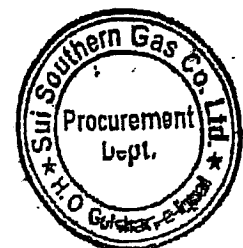

- 14.3 Evaluation may be carried out both on item or on group of items/single or multiple package basis depending upon the nature of requirement exclusively at the discretion of the company to ensure economic procurement.
- 14.4 Company reserve the right to settle the final terms of supply with the lowest evaluated and commercially responsive bidder. Any effort by the bidder (s) to influence the outcome of bid evaluation or placement of purchase order may result in disqualification of the bidder.

#### 15. Loading of Bids:

Bids may be loaded with following if offer found to be deviated from specifications, delivery schedule, terms & conditions without stating the amount involved in such deviation by following method:

- 15.1 The cost of compensation / loading amount for that item shall be derived from the bid itself.
- 15.2 If 15.1 is not possible, average of rates of other bidders, who have quoted for that item conforming to technical specification, shall form the basis for cost compensation/loading.
- 15.3 The company will encourage participation by local bidders who will be given price preference. Landed cost factor shall be determined as per prevailing Government policy / SRO. However they will submit details of local value addition on raw material imported by them and percentage of locally manufactured component with documentary evidence.

#### 16. Performance Bond:

- 16.1 In case purchase order value is above Rs:500,000, the successful bidders shall submit performance bond guarantee which is to be submitted within ten days from receipt of LOI or order along with integrity pact. The successful bidders shall submit a performance bank guarantee (PBG) in the form of a pay order or bank guarantee (specimen attached at Annexure-B) issued by a scheduled bank in Pakistan, for an amount equivalent to 10% of the total value of the purchase order or as specified, in the "letter of intent". The performance bond unless specified otherwise; shall remain valid till;
- 16.1.1 Completion of final satisfactory delivery in case of consumable items.
- 16.1.2 12-18 months from the date of satisfactory delivery of the equipment/machinery.
- 16.1.3 Satisfactory delivery/installation of system in case the installation responsibility is on supplier's part.
- 16.1.4 120 days in case of chemicals.
- 16.1.5 In case of locally manufacturing item, the PBG equivalent to 3 months delivery schedule will be required after placement of purchase order which should remain valid till completion of final satisfactory delivery of the ordered quantity.
- 16.1.6 In case of small diameter line pipe (MS/MDPE) the PBG shall remain valid up to 3 months after completion of satisfactory final delivery.
- 16.1.7 In case of Vehicles, Manufacturer's Warranty is required in lieu of PBG.
- 16.2 The guarantee will be released after completion of this period, subject to satisfactory performance of the supplied equipment/machinery/system as mentioned at 16.1 above. The supplier shall keep the guarantee valid at their cost until fulfillment of the obligations.
- 16.3 In case the bidder does not submit the performance bond as specified, the delivery time of goods shall be deemed to have commenced 10 days (15 days in case of import) from the issuance of letter of intent/purchase order. The proceeds of the performance bond shall be payable to the Company as compensation for any loss resulting from the supplier's failure to complete its work under the purchase order/ contract. The validity period of the performance bond is to be extended if the delivery date/period is being extended mutually by the Company/Supplier.
- 16.4 The performance bond will be discharged / returned by the Company not later than thirty (30) days following the date of completion of the supplier's work under the purchase order/contract including any warranty/guarantee/performance obligations as specified in the special conditions of contract. The supplier shall not be absolved of their liability to perform in case of encashment of performance bond by the Company, who shall have the right to claim and receive all damages/losses incurred due to non-performance.
- 16.5 The Company shall promptly notify the supplier in writing for any claim arising under this guarantee. Upon receipt of such notice, the supplier shall promptly repair or replace the defective goods or parts thereof, without cost to the Company other than, where applicable the cost of inland delivery of the repaired or replaced goods or parts from the port of entry to the final destination.

14.

- 16.6 If the supplier, having been notified, fails to rectify the defect (s) in accordance with the purchase order/contract, the Company may proceed to take such remedial actions as may be necessary at the supplier's expense. Any amount payable by the supplier under this clause may be recovered by the Company, by withdrawing from the performance bond without having to notify or seek the approval of the supplier.
- 16.7 Nothing herein contained shall be construed to limit supplier's obligation of performance of the order/contract to the value of the performance bond.
- 16.8 **Guarantee/Warranty:** In case where performance guarantee is not applicable, the supplier shall confirm that all supplied goods under the contract/purchase order are new, unused, of the most recent or current models and incorporate all recent improvements in design and goods unless provided otherwise in the contract/purchase order. This guarantee shall remain valid for a period of twelve to eighteen months after the goods have been delivered or commissioned.
17. **Purchase Order/Contract:**  
Purchase order of quoted material may be placed on fulfillment of conditions mentioned at 14 & 16 above which is through formal confirmation for proceedings with the suppliers.
18. **Assurance:**  
The successful bidder will be required to give satisfactory assurance of its ability and intention to deliver the goods, pursuant to the tender enquiry and contract within the time set forth therein.
19. **Force Majeure:**
- 19.1 In the event of either party hereto being rendered unable, wholly or partially, by force majeure circumstances to carry out its obligations under the purchase order/contract documents, such party shall give notice and full particulars and other satisfactory evidence of such force majeure circumstance(s) in writing or by fax to the other party within 7 days after the occurrence of the cause(s). Relieved upon the obligations of the party giving such notice so far as they are affected by such force majeure shall be suspended for the period during cause(s) shall, as far as possible, be remedied and obviated with all reasonable dispatch. The term 'force majeure' as employed herein, shall mean acts of God or public enemy, civil insurrection, fires, floods, earthquakes or other physical disasters, order or request of governments, blockade or embargo. It is, however, clarified that strikes, lockouts, shortage or non-availability of raw materials, rains, and disturbances, other labor dispute or congestion's in ports on the supplier's side shall not be included in the term 'force majeure'.
- 19.2 In case the force majeure contingencies last continuously for more than one month, both parties will agree on the necessary arrangements for the further implementation of the purchase order/contract. In case further implementation is unforeseeable and impossible, both parties shall arrange for the termination of the purchase order/contract, but without prejudice to their rights and obligations prior to such termination it being understood that each party shall fulfill its contractual obligations so far as they have fallen due before the operation of force majeure.
20. **Amendment in purchase order/contract:**
- 20.1 The Company may at any time by a written notice to the supplier make changes within the general scope of the purchase order/contract in any one or more of the following:-
- 20.1.1 Drawings, designs or specifications where goods to be furnished under the purchase order/contract are to be specifically manufactured for the Company.
- 20.1.2 The method of shipment or packing.
- 20.1.3 The place of delivery.
- 20.1.4 Quantities of item up to a maximum variance of +15% of purchase order/contract value.
- 20.2 Company reserves the right to increase/decrease the quantities or delete any or all items listed in the price schedule/schedule of requirement/bid form without assigning any reason.
- 20.3 Upon notification by the Company of such modifications the supplier shall submit to the Company an estimated cost for the proposed modification within ten (10) calendar days of receipt of notice of the modification and shall include an estimate of the impact (if any) of the modification on the delivery dates under the purchase order/contract, as well as a detailed schedule for the completion of the modification, if applicable.





SSGC

- 20.4 The supplier shall not perform modification in accordance with clause 20.1 above until the Company have authorized a modification order in writing on the basis of the estimate provided by the supplier as described in clause 20.3.
- 20.5 Modification mutually agreed upon shall constitute a part of the work under the purchase order/contract and the provisions and conditions of the contract shall apply to the said modification.
- 20.6 If modification made by the Company results in a variation in purchase order/contract quantities whose net cost effect is within 15% of the total value then the original purchase order/contract rates would be applicable. Any "modification" affecting the quantities and the corresponding cost effect beyond 15 percent would be mutually agreed upon between the Company and the supplier.

**21. Extension in delivery period:**

- 21.1 Delivery of the goods shall be made by the supplier in accordance with the schedule of requirement and delivery period; however, the supplier may claim extension of the time limits as set forth in the schedule of requirements and delivery period in case of
- 21.1.1 Modification in the goods ordered by the Company pursuant to clause 20.
- 21.1.2 Delay in provision of any services which are to be provided by the Company (services provided by the Company shall be interpreted to include all approvals by the Company under the contract).
- 21.1.3 Delay in performance of work caused by orders issued by the Company.
- 21.2 The supplier shall demonstrate to the Company's satisfaction that it has used its best endeavors to avoid or overcome such causes for delay and the parties will mutually agree upon remedies to mitigate or overcome such causes for delay.
- 21.3 Notwithstanding clause 21.1 above, the supplier shall not be entitled to an extension of time for completion unless the supplier at the time of such circumstances arising, immediately has notified the Company in writing of any delay that it may claim as caused by circumstances pursuant to clause 21.1 above and upon request of the Company, the supplier shall substantiate that the delay occurred is due to the circumstances referred by the supplier.

**22. Packing:**

- 22.1 The material shall be in original/sealed packing to ensure delivery without any damage during transit.
- 22.2 If any of the good is discovered to be damaged or unacceptable at the point of embarkation, the supplier shall be responsible for replacement of those goods free of any charge and cost to the Company, within the delivery time schedule of the contract/purchase order.
- 22.3 The identification marks showing contents, quantity and contract/purchase order number shall be printed on each skid/metal container/case containing one copy of invoice & packing list.
- 22.4 **Handling and Transportation:**  
The Supplier shall arrange for the proper stacking of the Goods and for its proper storage and lashing and for other such provisions/suitable measures as may be necessary to safeguard against movement and damage to the Goods from the point of loading to its designated destination.

**23. Inspection:**

- 23.1 Pre-delivery inspection may be carried-out at the premises of supplier(s) and/or post delivery inspection at company's any location, by the appointed inspector/inspection team, third party inspectors appointed by the Company.
- 23.2 The Company reserves the right to arrange inspections and tests to the goods or manufacturing processes at any stage at any of the premises of the supplier or its subcontractor(s) or and at the point of delivery and at the goods final destination. Where conducted on the premises of the supplier or its sub-contractor(s), all reasonable facilities and assistance including access to drawings and production data shall be furnished to the inspector at no charge to the Company. Such inspection, however, shall not relieve the Supplier to fulfill the obligations under the



purchase order/contract. If goods fail to conform to the specifications, the Company may reject them.

#### 24. Delivery:

- 24.1 Free delivery at any of the following locations, unless specified otherwise:
- 24.1.1 R & D Section, Stores Department Abul Hasan Isphahani Road, Karachi
  - 24.1.2 R & D Section, Stores Department F-37, SITE Karachi.
  - 24.1.3 R & D Section, Stores Department F-76, Dope Yard SITE, Karachi.
  - 24.1.4 Meter Manufacturing Plant, Sir Shah Suleman Road, Gulshan-e-Iqbal Karachi.
  - 24.1.5 Khadeji Store, 57th Kilometer at Super Highway Karachi.
  - 24.1.6 Any other location specified by the company.
- 24.2 Delivery period shall commence after 10 days (15 days in case of import) of the issuance of letter of intent or from the date of purchase order/contract whichever is earlier, unless otherwise specified.
- 24.3 The supplier shall replace defective material at their risk & cost including transportation, duty, taxes etc.
- 24.4 GST Invoice if applicable be submitted at R&D section Stores Department along with material & delivery challan.
- 24.5 Unloading and stacking through cranes, fork lifters, labor etc. will be arranged by supplier at delivery site (for material like Pipes/Heavy Machinery & Equipment etc).
- 24.6 Delivery is to be made strictly in accordance with "delivery schedule" as specified by the Company.
- 24.7 The rejected material is to be collected/lifted by the supplier within a maximum period of one month after its intimation by the Company. Beyond specified period, the Company shall not be responsible for storage/safety of the uncollected material.

#### 25. Delivery Failure:

- 25.1 In case the supplier fails to supply/ship the material within the stipulated period, the Company have the right to make an alternative arrangement for the purchase of the goods on such terms as may be offered. In such event all losses, cost and charges sustained/incurred by the Company on stated purchase shall be recovered from the Supplier without prejudice to any other right or remedy available to the Company which includes recovery of losses sustained by the Company from any due payment of the said supplier.
- 25.2 In the event Company remains unable to make such alternative arrangements, the Company has the right to recover from the supplier any or all losses sustained as a result of the supplier's failure to ship/supply the goods as per schedule of delivery.
- 25.3 In the event Company being forced to purchase any quantity or any other alternative not specified in this document as a result of any failure to supply/ship the material, the Company shall have the right to terminate the contract/purchase order without prejudice to any other rights or remedies available to the Company.

#### 26. Payment:

- 26.1 The supplier after delivery of goods and its acceptance shall submit invoice to Finance Department of the Company, containing following information i.e.
- (a) Purchase order No. & date.
  - (b) Items
  - (c) Quantity
  - (d) Price
  - (e) Invoice value
  - (f) Point of delivery
  - (g) Delivery challan indicating delivery date, etc.

Payment will be made within 30 days of completion of stated formalities.

- 26.2 Income Tax @ 3.5% or as applicable under the prevailing government rules will be deducted at source (except where the supplier provides an income tax exemption certificate). Quoted price shall be inclusive of all taxes, except GST, which shall be mentioned separately. Supplier(s) are required to submit signed and stamp acknowledgement slip, Sales Tax return, Annex "C" & Annex "I" (whichever applicable) in which Sales Tax (of relevant Sales Tax invoice) is paid.

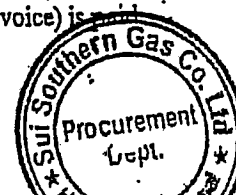

- 26.3 In case supplier is not liable to pay tax under the income tax ordinance or is liable to pay tax at a lower rate the supplier shall obtain a certificate from the tax authorities in Pakistan to that effect. In case the required certificate is not produced by the supplier prior to the date of payment, then the Company shall deduct tax at source from the gross payment payable to supplier.

27. **Liquidated damages:**

- 27.1 If supplier fails to deliver ordered material within the stipulated period/scheduled time specified in purchase order, Company, without prejudice to any other remedies, shall deduct from the bill or any other due payments/guarantees, as liquidated damages, a sum equivalent to 0.1% per day of the undelivered goods up to maximum 10%. The liquidated damages shall also be applicable for the cancelled quantity of goods under clause 28.

- 27.2 Whenever liquidated damages become payable, in the event that delivery of all goods and equipment is not made within the time period specified except on account of force majeure, the Company shall quantify the same and shall serve notice to the supplier requiring payment thereof. If the supplier fails to remit payment within 15 days of receipt of such notice, the Company shall forth-with become entitled to recover the same without recourse to the supplier, by calling upon The Performance Bond, withdrawals by way of liquidated damages shall not reduce the value of the Performance bond.

- 27.3 The payment of liquidated damages shall not relieve the supplier from performing and fulfilling all its obligations under the contract/purchase order nor shall the right and entitlements of the Company be affected or reduced in any manner.

- 27.4 In case of order placed on FOB/C&F basis, the delivery period shall commence from the date of confirmation of L/C. However, delayed submission of PBG period in excess of time limit will be deducted from the delivery period for the purpose of recovery of late delivery charges.

- 27.5 The liquidated damages shall be the sum equivalent to point one (0.1%) percent of the Contract price of the delayed goods as unperformed services for each day of delay, until actual delivery or performance, up to a maximum deduction of ten (10) percent of the Contract price. Once this maximum is reached, the Company may consider termination of the Contract at the risk and cost of the Supplier.

28. **Default by Supplier:**

- 28.1 The Company may, without prejudice to any other remedy by written "notice of default" sent to the supplier, cancel the purchase order whole or in part; if:

28.1.1 The supplier fails to deliver any or all of the ordered quantity as per specified delivery schedule or any extension thereof granted by the Company

28.1.2 The supplier fails to perform any other obligation(s) under the "purchase order".

28.1.3 The Company during the delivery period has reasons to believe that the supplier will not be able to fulfill the obligations under the purchase order/contract.

The Company prior to exercising its right to cancel the purchase order/contract shall issue notice to the Supplier specifying the default(s) and the supplier shall submit an explanation within seven (07) days of receipt of such notice. If such explanation is not furnished within the stipulated time or if so furnished, is found to be unsatisfactory and/or the default(s) continues, purchase order/contract may be cancelled. The Company in addition to cancellation of purchase order/contract may suspend/cancel the enlistment of supplier.

- 28.2 The Company shall have the right to terminate/cancel the contract/purchase order concluded between the supplier and Company; if:

28.2.1 The successful bidder fails to furnish the performance bond as under clause 16 thereof.

28.2.2 The supplier fails otherwise to perform, fulfill or comply with terms, conditions, regulations and requirements of the contract/purchase order to carry out the work in accordance with the provisions thereof or abandons the shipment

28.2.3 The supplier becomes bankrupt or insolvent or makes an assignment for the benefit of its creditors.

28.2.4 One or more consignments of material delayed by a period of more than three months or non-supplied.

28.2.5 Rejection of manufacturing items as a result of observation by inspection team.

- 28.2.6 Penalty on higher rejection rate of supplied goods.
- 28.3 The supplier shall have the right to terminate the contract/purchase order if-
- 28.3.1 The Company fails to establish the "letter of credit" within the stipulated period as required.
- 28.3.2 The Company becomes bankrupt or insolvent or makes an assignment for the benefit of its creditors.
- 28.3.3 The Company is in default and breach of its obligation and liabilities under the contract/purchase order.
29. **Resolution of dispute:**  
The Company and the supplier shall make every effort to resolve the disagreement or dispute arising between them amicably by direct discussion under or in connection with the purchase order/contract.
30. **Applicable law:**  
The purchase order/contract shall be governed by and interpreted in accordance with the laws of the Islamic Republic of Pakistan.
31. **Declaration/Integrity Pact/Certification:**
- 31.1 Successful supplier shall furnish the declaration (specimen attached at Annexure-C) within 10 days after issuance of LOI/order /contract if the order/contract value becomes Rs:10 million or above.
- 31.2 In case of F.O.B/C&F Purchase order/Contract, the Principal as well as "local agent" both will sign the "integrity pact" as required under this clause.
- 31.3 Bidders to submit a certificate on Rs:100/- non-judicial stamp paper certifying that they are not black listed by the Government/Autonomous bodies and declared as defaulted supplier.
32. **Arbitration/resolution of disputes:**
- 32.1 Any difference or dispute arising out of or in connection with the contract between the Company and the supplier which can not be amicably resolved shall be referred to arbitration in Karachi, Pakistan, to two arbitrators, one appointed by each party of such difference/ dispute. In case the judgment of the said Arbitrator being at variance, the matter shall be referred to an "umpire", who shall be appointed by both the side Arbitrators. The umpire shall be retired judge of a High Court or the Supreme Court of Pakistan. Such arbitrators and umpire shall together proceed to adjudicate the disputes in accordance with the Arbitration Act, 1940, as amended from time to time.
- 32.2 Prior to exercising any right by the Company or supplier to terminate the purchase order/contract under the conditions stipulated above, a return notice shall be required to be given to the other party specifying such default(s) and calling for submission of an explanation within seven (7) days of receipt of such notice. If such explanation is not furnished within the stipulated time or if so furnished, is found to be unsatisfactory, and the default(s) continuous, the purchase order/contract be terminated with notice to other party.
- 32.3 The agreement shall be governed by Law of Islamic Republic of Pakistan and the arbitration language shall be English.
- 32.4 During the course of arbitration, the supplier shall not suspend the performance of his responsibilities and obligations under the contract unless authorized by the Company in writing to do so.
- 32.5 In addition to the remedies as stated above, there is a "grievance committee" formed by the Company which can be approached by supplier in case of non-settlement of issues at any stage if supplier feels that settlement is not insight or not justified.
33. **Redressal of grievances by the procuring agency:-**
- 33.1 Grievance Committee is in place to address the complaints of bidders that may occur prior to entry into the procurement contract.
- 33.2 Aggrieved bidder may lodge a written complaint concerning his grievances not later than fifteen days after the announcement of the bid evaluation report.
- 33.3 Bidder is to submit complaint on letter head duly signed by the authorized person. Tender reference, details / nature of complaint, complainant active telephone, cell, postal address, email



address must necessarily be provided. Incomplete / anonymous complaints will not be responded at all.

33.4 The Committee shall investigate and decide upon the complaint within fifteen days of the receipt of the complaint

33.5 Mere fact of lodging of a complaint shall not warrant suspension of the procurement process.

**34. Blacklisting of Suppliers and Contractors:**

The Company shall permanently blacklist or temporarily debar (at least for 6-months from participating in SSGC's tender proceedings) if, a supplier or contractor who either constantly fails to perform satisfactorily performance or found to be indulged in corrupt and fraudulent practices as defined below:

34.1 Corrupt and fraudulent practices" include the offering, giving, receiving, or soliciting of anything of value to influence the action of an officer/Company.

34.2 If the supplier/contractor found responsible for the detriment of the Company during proceedings of procurement/contract, prior to its execution.

34.3 Misrepresentation of facts in order to influence the procurement process or the execution of the purchase order/contract.

34.4 Collusive practices among bidders (prior to or after bid submission) designed to establish bid prices at artificial, non- competitive levels and to deprive the Company of the benefits of free and open competition.

**35. Supplier's Guarantee and Responsibilities:**

The Bidder/Supplier shall guarantee that the materials supplied against this tender enquiry is new and is of acceptable quality and has been tried and approved on similar jobs. The validity and scope of such guarantee will be in accordance with conditions stated in this document. In case the opinion of the Company the Goods fail to perform the services in accordance with the specifications specified in Section IV due to manufacturing defects/defective material and/or workmanship, the Supplier shall replace, repair or reconstruct such Goods at his own cost in Pakistan wherever the Goods shall be located so that such Goods shall be restored to such conditions that it shall perform in satisfactory operating condition or to replace it with new Goods at Supplier's cost so that the goods shall perform in accordance with the specifications and details as set forth in the Contract/tender documents. If the Supplier shall fail to do so after expiry of 15 days notice to this effect served on him by the Company, the Company shall be at liberty to repair, replace and/or reconstruct the Goods at its costs provided in the event, the Company shall be entitled to recover total cost of such replacement from the Supplier withdrawing from the Performance Guarantee.

**36. Language:**

The bid prepared by the bidder and all correspondence and documents relating to the bid exchanged by the bidder and the Company shall be written in English language. Any printed literature furnished by the bidder may be written in another language provided that this literature is accompanied by an English translation in which case for purpose of interpretation of the bid, English translation shall govern.

**37. Vehicle Applied by Authorized dealer of local manufacturer :**

Incase of vehicle supplied by authorized dealer of local manufacturer, the authorized dealer will be responsible to get the vehicle (s) registered through Excise Department Government of Sindh and provide Original Registration book / Original Registration Invoice / Tax payment receipt / other related documents & provide the vehicle (s) number plate (s) to SSGC. Registration fee will be reimbursed by SSGC subject to submission of Government of Sindh Excise Department receipt.

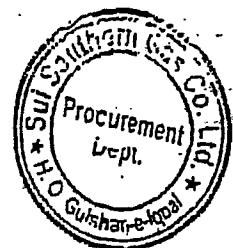

## Additional Terms for Tenders on F.O.B.JC&amp;F basis:

## 1. Submission of bids:

- 1.1 Bid bond (Earnest money) @ 2% of the total F.O.B value as per clause 9, of section 1 of "General terms & conditions" is required to be submitted with the bid. It may be noted that bids without bid bond will be rejected and returned to bidder.
- 1.2 In case the bidder is manufacturer the bid shall either be completely prepared by the foreign bidder including signing and stamping of all documents. In case, such documents are being signed by the local agent of the bidder, the bid shall essentially include supplier's original Performa invoice and an original authority letter in favor of local agent to sign the documents on their behalf. The bid is liable for rejection if these conditions are not met.
- 1.3 In case of Bidder offering to supply goods which the bidder did not manufacture or otherwise produce, the bidder shall be duly authorized by the goods manufacturer or the producer to submit bid or supply the goods on their behalf.
- 1.4 Bids shall be submitted (preferably through local agents) in two copies, (original + copy).
- 1.5 The price on unit FOB and C&F basis is to be quoted separately. Following are to be essentially indicated in the bid form:
- 1.5.1 Country of origin.
- 1.5.2 Port of shipment.
- 1.5.3 Estimated gross/net weight, dimension & volume of offered item and estimated weight of each item.
- 1.5.4 Delivery period or schedule in case of bulk quantities.
- 1.5.5 Original technical literature.
- 1.5.6 Beneficiary's complete address.
- 1.6 Foreign bank charges and L/C confirmation charges will be borne by the supplier.

## 1.7 Bid Currency:

The rates shall be quoted in bidder's home country or in United States Dollars. A bidder expecting to incur a portion of its expenditures in the performance of the contract in more than one currency and wishing to be paid accordingly shall indicate the same in their bid. However, bidder from Pakistan would be paid in Pak Rupee.

(Clause 1.5 of General Terms & Conditions is not applicable)

## 2. Bid bond:

- 2.1 Bid bond shall be equivalent to two percent (2%) of the total F.O.B value, in favor of Sui Southern Gas Company Limited and shall be in the form of pay order, demand draft, call deposit receipt or a bank guarantee (specimen attached at Annexure-A), issued by a scheduled bank in Pakistan. The bid bond shall remain valid for 120 days (150 days in case of Single Stage Two Envelope bidding procedure) unless specified otherwise. The bid bond shall be returned/refunded to the un-successful bidders while the bid bond of the successful bidder shall be retained, till submission of Performance bond. Bids without bid bond will not be considered. In case the order value is less than US\$25,000 the bid bond in lieu of performance bond, will be retained till fulfillment of obligations by the supplier. However, in either case the bidder is responsible to arrange the extension of bid bond validity as per requirement. If bid bond submitted by the supplier is more than 2% of ordered value, it may be replaced with appropriate value. Bid bonds of non-compliant bidders may be released during evaluation process. The bid bond shall be denominated in the currency of the bid or any other freely convertible currency.
- 2.2 Bid submitted on behalf of different principals shall be required to submit separate bid bond along with the bid for each offer.
- (Note as mentioned at Clause 9, 9.1 & 9.2 of General Terms & Conditions shall also apply).

## 3. Conversion to single currency:

In order to carry out evaluation and comparison, the Company will convert all bid prices expressed in various currencies to Pak Rupees at the buying exchange rates established by the State Bank of Pakistan or any other commercial bank in Pakistan for similar transactions on the date of opening of bids. In case of Two Envelope Bidding System, the exchange rates prevailing at the time of opening of Technical Proposals will be used for conversion and evaluation.

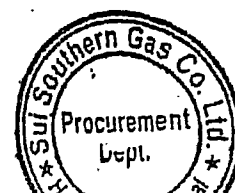

4. Evaluation Criteria:

- 4.1 The evaluation of bids will be carried out on C&F / landed cost basis, however purchase order will be placed on FOB price on freight to collect basis. The bidders are required to submit best freight charges obtained by them from Pakistan National Shipping Corporation (PNSC) in order to have a uniform basis to arrive at C&F cost. Bill of lading to indicate "freight payable by the consignee at destination" in local currency. Foreign currency exchange rate (selling) will be considered as of bid "opening date".
- 4.2 In the case of goods to be offered from outside Pakistan, custom duties and other similar import taxes which are applicable shall be added to the bid.
- 4.3 In case shipment by air it shall be arranged through Company's airfreight forwarder (s) or their nominated agent. "on freight to collect basis".

(Clause No. 14.3 to 14.4 of General Terms & Conditions are also to be applicable).

5. Loading of Bids:

Freight charges from port of loading up to Karachi port or unit C&F value must be indicated in bid form, failing, which bid will be loaded by 5 to 10% freight charges. Bid will be declared non-compliant if loading results an extensive increase in price of material.

(Clause 15 of General Terms & Conditions is also applicable).

6. Performance bond:

- 6.1 In case purchase order value is US\$-25,000/- or above or equivalent for other currencies, letter of intent will be issued to successful bidders for submission of performance bond guarantee which is to be submitted within 15 days from receipt of L.O.I. The successful bidders shall submit a performance bank guarantee (P.B.G) in the form of bank guarantee (specimen attached at Annexure-B) issued by a scheduled bank in Pakistan, for an amount equivalent to 10% of the total value of the purchase order or as specified, in the letter of intent. The performance bond unless specified otherwise, shall remain valid till:

- 6.1.1 Completion of final satisfactory delivery in case of consumable items.
- 6.1.2 12-18 months from the date of satisfactory delivery of the equipment/machinery.
- 6.1.3 Satisfactory delivery/installation of system in case the installation liabilities will be on supplier's part.
- 6.1.4 120 days in case of chemicals.

- 6.2 The Letter of Credit shall be operative upon receipt of Performance Bond (as specified in para6.1) and integrity pact, any delay due to late submission of Performance Bond will be on supplier's account. Late submission of PBG should not affect the delivery schedule.

- 6.3 The performance bond shall be denominated in foreign currency or in currency of the contract/purchase order or in a freely convertible currency acceptable to the Company and shall be in the form of a bank guarantee.

- 6.4 In very special case subject to approval of the management, the P.B.G could be acceptable in Pak Rupee. However, an undertaking should be given by the supplier that in case of encashment of P.B.G supplier shall deposit short fall amount due to Pak Rupee exchange rate.

6.5 Warranty/Guarantee:

In case where performance guarantee is not applicable, the supplier shall warrant that all goods supplied under the contract/purchase order are new, unused, of the most recent or current models and all recent improvements in design and goods have been incorporated, unless provided otherwise in the contract/purchase order. This guarantee shall remain valid for a period of twelve to eighteen months after the goods have been delivered or commissioned.

(Clause 16.2 to 16.8 of General Terms & Conditions are also applicable).

7. Delivery:

- 7.1 In case of "FOB" order (contract, shipments) shall be effected per vessel of Pakistan National Shipping Corporation (PNSC) owned or chartered vessels on "freight to collect" basis. Bill of lading to indicate "freight payable by the consignee at destination". In case goods ready for shipment and the PNSC vessel is



not available at port of loading, supplier shall intimate the same to Company immediately so that matter could be taken with PNSC in Pakistan.

7.2 In case of C&F order/contract, the supplier hereby guarantees/ensure:

- 7.2.1 To use clean and dry vessel suitable for marine transportation and shall not use tramp vessels.
- 7.2.2 The goods/material will be shipped/dispatched with all care and diligence at their risk & cost and goods to be stored below deck. Accordingly, the supplier shall be responsible for all damages/losses during inland and marine transportation from the supplier's plant until arrival at Karachi port.
- 7.2.3 To provide as part of its work all services and functions related to handling, loading, unloading, lashing and securing in ship's holds and all costs, charges and expenses of which shall be included in the purchase order/contract price, unless otherwise specified:

7.3 In case of FOB order/contract, the supplier's obligations shall be over after the goods have crossed the ship's rails. The co-ordination, scheduling and lining-up for a PNSC vessel shall be the obligation of the supplier.

7.4 The supplier shall reimburse the Company all additional duties, taxes and other such charges paid by the Company on account of short shipment by the supplier for all items subsequently shipped on a no-charge basis or otherwise by the supplier. The supplier shall also reimburse the Company all additional duties, taxes and other such charges paid by the Company on account of incorrect invoicing by the supplier.

7.5 Shipment shall be deemed to have been made when the supplier has shipped the goods against a clean bill of lading and all other such documentation, as specified in clause 9.3 & 9.4 appearing next in sequence) have been furnished to the Company.

7.6 The supplier shall ensure that all above mentioned acts and other incidental and ancillary functions are conducted in accordance with sound and acceptable engineering practices. The Company shall be entitled to oppose any incorrect or inadequate practice adopted by supplier in this respect and the supplier shall take corrective action/measure forthwith to correct such omissions. If any goods are discovered to be damaged or unacceptable at the point of loading, the supplier shall be responsible for replacement free of all charges and costs to the Company within the delivery period specified in the purchase order/contract.

#### 8. Insurance:

8.1 All goods supplied under the purchase order/contract shall be fully insured in a freely convertible currency against loss or damage incidental to manufacture or acquisition, transportation, storage and delivery in the manner specified in delivery clause 7.

8.2 Marine Insurance shall be the responsibility of the Company unless otherwise specified.

8.3 The supplier shall advise the Company by fax at least seven (7) days prior to the expected date of shipment, the following particulars:-

- 8.3.1 Name of the vessel and of the shipping company.
- 8.3.2 Age of the vessel (which should be less than 20 years).
- 8.3.3 Lloyd's 100A1 or equivalent classification of the vessel.
- 8.3.4 ETD from Port of dispatch and ETA at Karachi
- 8.3.5 FOB/C&F value of the consignment.

The above information shall also be transmitted to the Company's underwriters, M/s. National Insurance Corporation by fax No. 0092-21-9202779 and to the Company referring Policy No. NIF/M/K/OP/002/73.

#### 9. Payment:

9.1 Payment of FOB/C&F prices shall be made in the currency of bid through an irrevocable letter of credit (L/C) established in favor of the supplier, negotiable through the bank of their choice. Bidder shall indicate full name and address of the negotiating bank and the place at which they wish to negotiate the letter of credit. All bank charges outside Pakistan will be on supplier's account and all bank charges within Pakistan will be at Company's account. If confirmed letter of credit is required then charges for confirmation will be on supplier's account.

9.2 The supplier's request (s) for payment shall be made to the Company in writing as follows:

9.2.1 It shall be accompanied by an invoice describing, as appropriate, the goods delivered and the services incurred and by shipping documents submitted pursuant to Clause 9.4 hereof and upon fulfillment of other obligations stipulated in purchase order/contract.

9.2.2 Against shipping documents on arrival of ordered material at consignee destination. Bidder (s) will have to clearly mention, if they wish to opt for this mode of payment

9.3 The letter of credit shall be available upon presenting the following documents to the negotiating bank within 15 days of the date of the bill of lading covering shipment of each consignment:

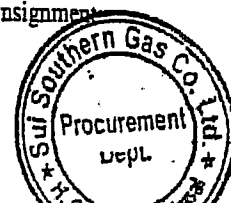



SSGC

- |        |  |       |                                |
|--------|--|-------|--------------------------------|
| 9.3.1- | Invoice  | ----  | 4 copies                       |
| 9.3.2- | Packing list   | ----- | 4 copies                       |
| 9.3.3- | Bill of lading " freight to be paid by consignee at destination" evidencing shipment in terms of the purchase order to Karachi-Pakistan made copies. out to order in the name of Co.'s bank, Notify party Sui Southern Gas Company Ltd., | ----- | 3 originals & 6 non-negotiable |
| 9.3.4- | Certificate of Origin (Verified/ Endorsed by Chamber of Commerce)  | ---   | 2 copies                       |
| 9.3.5- | Manufacturers test certificate/  | ----  | 2copies Inspection report.     |

9.4 Without prejudice to the supplier's responsibility for providing documents mentioned as at 9.3.1 to 9.3.5 above to bank, the supplier shall forward the following non-negotiable documents directly to Company immediately after shipment so as to reach the Company at least 15 days prior to the arrival of the vessel at Karachi port.

- |       |  |     |          |
|-------|--|-----|----------|
| 9.4.1 | -Invoice   | --- | 6 copies |
| 9.4.2 | -Bill of Lading  | --- | 6 copies |
| 9.4.3 | -Packing List  | --- | 6 copies |
| 9.4.4 | -Certificate of Origin (Verified /Endorsed by Chamber of Commerce) | --- | 2 copies |
| 9.4.5 | -Manufacturers Test Certificate/                                   | --- | 2 copies |

Inspection Report.

9.4.6 The invoice to be exactly as per order/contract. Any deviation which render or cause the company to pay demurrage or any other charges with respect to clearance/handling etc. will be borne by the supplier.

9.5 No payment hereunder shall be deemed to be accepted by the Company of the goods covered by such payment nor release the supplier from responsibility thereof under the terms of the purchase order/contract.

9.6 If the Company is compelled to pay demurrage or storage charges or incurs any loss or suffers any damage at Karachi Port on account of non-compliance by the supplier of above requirements, the Company shall be entitled at their sole discretion to recover the same amount from supplier.

10. Termination of purchases order by supplier:

10.1 The supplier shall have the right to terminate the contract/purchase order if:-

10.1.1 The Company fails to establish the letter of credit within the stipulated period as required under clause 9.1 hereof after the supplier has made compliance with the provisions of clause 6.

10.1.2 The Company becomes bankrupt or insolvent or makes an assignment for the benefit of its creditors.

10.1.3 The Company is in default and breach of its obligation and liabilities under the contract/purchase order.

11. Installation/Commissioning/Training:

If installation/commissioning and training is required, the charges will be paid in Pak Rupee and will be subject to deduction of all local duty and taxes (as applicable).

12. Vehicle (s) supplied by foreign manufacturer / principal:

12.1 In case of supply of any type of vehicle (s) / earth moving vehicle (s) by the foreign principal / manufacturer. After clearance of vehicle from the custom, the local agent of the foreign supplier / manufacturer / principal will be completely responsible to get the vehicle (s) registered through Excise Department Government of Sindh and provide Original Registration book / Original Registration Invoice / Tax payment receipt / other related documents & provide the vehicle (s) number plate (s) to SSGC. Registration fee will be reimbursed by SSGC subject to submission of Government of Sindh Excise Department receipt.

12.2 The bidder / supplier shall quote only those vehicle (s) / which fully comply to Pakistani environment and can operate in Pakistan. The bidder should ensure that vehicle (s) consumables (fuel/oil & lubricant/ spares) are easily available in Pakistan.

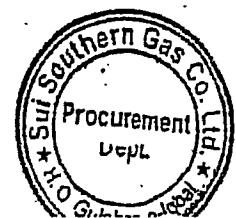

On Non Judicial Stamp Paper of Rs. 50/- (Fifty) Per 100,000  
Format of Bid Bond Guarantee

BANK GUARANTEE NO.....

DATE OF ISSUE.....

DATE OF EXPIRY.....

AMOUNT.....

Sui Southern gas Company Limited,  
ST. 4/B, Block-14,  
Guishan-e-Iqbal,  
Sir Shah Suleman Road,  
Karachi.

Dear Sirs,

**Bid Bond Bank Guarantee**

In consideration of M/s..... hereinafter called the Bidder  
having submitted the accompanying bid & in consideration of value received from Bidder we hereby agree and  
undertake as follows:

1. To make unconditional payment of Rs..... upon your written demand without further recourse, question or reference to the Bidder or any other person in the event of withdrawal of the aforesaid bid by the Bidder before the end of the period specified in the bid after the opening of the same for the validity thereof or if no such period to be specified within 90 days (150 days in case of Single Stage Two Envelope bidding procedure) after said opening and or in the event that the Bidder shall within the period specified therefore or if no period specified within 15 days after the prescribed forms are presented to the Bidder for signature the Bidder shall fail to execute such further contractual documents if any, as may be required by the terms of the bid as accepted or on the Bidder failure to give the requisite Performance Bond as may be required for the fulfillment of resulting contract.
2. To accept written intimation (s) from you as conclusive and sufficient evidence of the existence of a default of non-compliance as aforesaid on the part of Bidder and to make payment accordingly within 03 days of the receipt of the written intimation.
3. No grant of time or other indulgence to, or composition or arrangement with the Bidder in respect of the aforesaid Bid with or without notice to us shall in any manner, discharge or otherwise, however, effect this Guarantee and our liabilities & commitments hereunder.
4. This Guarantee shall be binding on us and our successors in interest and shall be irrevocable.

Yours faithfully,

(stamp and signature of the issuing bank)

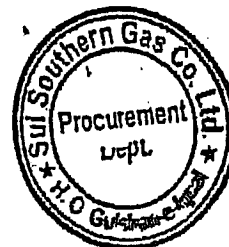

SSGC

Annexure- B

On Non Judicial Stamp Paper of Rs. 50/- (Fifty) Per 100,000  
Format of Performance Bond Guarantee

BANK GUARANTEE NO.....  
DATE OF ISSUE.....  
DATE OF EXPIRY.....  
AMOUNT.....

Sui Southern Gas Company Limited,  
ST. 4/B, Block-14,  
Gulshan-e-Iqbal,  
Sir Shah Suleman Road,  
Karachi.

Dear Sirs,

In The Sum of Rs.....Account.....  
-To You in Karachi under the Purchase

In consideration of your having placed Purchase Order No.....  
dated..... On M/s..... called Supplier and in  
consideration for value, received from Supplier, we hereby agree and undertake as under:

1. To make unconditional payments to you from time to time as called upon or make an unconditional payments Rs..... Being Ten Percent (10%), of the value of the Purchase Order price mentioned in the said Purchase Order, on your written demand(s) without further resource, question or reference to Supplier or any other person, in the event of default or non-performance and / or non-fulfillment by Supplier of his obligations liabilities & responsibilities under and in pursuance of the said Purchase Order of which you shall be the sole judge.
2. To accept written intimation from you as conclusive and sufficient evidence of the existence of a default or breach as aforesaid on the part of Supplier and to make payment accordingly within 3 (three) days of receipt thereof.
3. To keep this guarantee in full force from the date hereof as specified in General or Special terms & conditions.
4. That on grant of time or other indulgence to amendment in the terms of the purchase order by agreement with Supplier in respect of the Performance of his obligations under and in pursuance of the said Purchase Order with or without notice to us, shall in any manner discharge or otherwise, however, affect this Guarantee and our liabilities and commitments there under.
5. This Guarantee shall be binding on us and our successors in interest and shall be irrecoverable.
6. This Guarantee shall not be affected by any change in the constitution of the Guarantor Bank or the constitution of M/s .....the Supplier.

Yours faithfully,

(stamp and signature of the issuing bank)

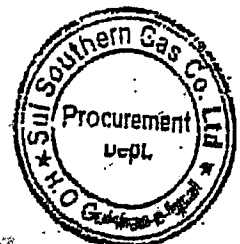

## (Format of Declaration)

General Manager (Procurement)  
Sui Southern Gas Company Limited,  
ST. 4/B, Block-14, Gulshan-e-Iqbal,  
Sir Shah Suleman Road, Karachi.

Dear Sir,

**Declaration**

\_\_\_\_\_ (the Seller/Supplier) hereby declares its intention not to obtain or induce the procurement of any contract, right, interest, privilege or other obligation or benefit from Sui Southern Gas Company Limited or any administrative subdivision or agency thereof of any other entity owned or controlled by it (SSGC) through any corrupt business practice.

Without limiting the generality of the foregoing, (the Seller/Supplier) represents and warrants that it has fully declared the brokerage, commission fees etc. paid or payable to anyone and not given or agreed to give and shall not to give or agree to give to anyone within or outside Pakistan either directly or indirectly through any natural or juridical person, including its affiliate, agent, associate, broker, consultant, director, promoter, shareholder, sponsor or subsidiary, any commission, gratification, bribe, finder's fee or kickback, whether described as consultation fee or otherwise, with the object of obtaining or inducing the procurement of a contract, right, interest, privilege or other obligation of benefit in whatsoever form from SSGC, except that which has been expressly declared pursuant hereto.

(The Seller/Supplier) certifies that it has made and will make full disclosure of all agreements and arrangements with all persons in respect of or related to the transaction with SSGC and has not taken any action or will not take any action in circumvent the above declaration, representation or warranty.

(The Seller/Supplier) accepts full responsibility and strict liability for making any false declaration, not making full disclosure, misrepresenting facts or taking any action likely to defeat the purpose of this declaration, representation any warranty. It agrees that any contract, right interest, privilege or other obligation or benefit obtained or procured as aforesaid shall, without prejudice to any other rights and remedies available to SSGC under any law, contract or other instrument, be voidable at the option of SSGC.

Notwithstanding any rights and remedies exercised by SSGC in this regard, (The Seller/Supplier) agree to indemnify SSGC for any loss or damage incurred by it on account of its corrupt business practices and further pay compensation to SSGC in an amount equivalent to ten times the sum of any commission, gratification, bribe, finder's fee or kickback given by (The Seller/Supplier) as aforesaid for the purpose of obtaining or inducing the procurement of any contract, right, interest, privilege or other obligation or benefit in whatsoever form from SSGC.

Yours faithfully,

\_\_\_\_\_  
Signature & Stamp (The seller/supplier)

Note:

1. The above declaration is required to be submitted by the Successful Bidder after issuance of Purchase Order (PO) or Letter of Intent (LOI) on Bidder's letter head, for purchase order / letter of intent of a total value of Rs. 10,000,000/- (Ten million) or above.
2. Please note that submitting the declaration is a mandatory requirement.



SUI SOUTHERN GAS COMPANY LIMITED  
PROCUREMENT DEPARTMENT

**BLACKLISTING MECHANISM**  
**(REVISION-1)**

**1 BACKGROUND**

In pursuance of Rule-19 of Public Procurement Rules, 2004 read with Rule-2(f) (fa) and the criteria for Blacklisting of Suppliers and Contractors / Consultants doing business with the SSGCs is reiterated hereafter to eliminate unfair trade practices.

**2 SCOPE**

The procedure shall be applicable and remain in force, along with any amendments thereto, within Sui Southern Gas Company Limited ("SSGC") until any clear instructions or guidelines are impacted by the Government through Public Procurement Regulation Authority (PPRA), Pakistan Engineering Council (PEC), or any other competent forum. The procedure shall also be applicable on the pre-qualified firms. The procedure shall be applicable on any "Person(s) / Firm(s)", which for the purposes of this Mechanism shall inter alia include suppliers, bidders, contractors, consultants, firms, individuals, and organizations transacting business with SSGC. Wherever any provision of this Mechanism shall be in conflict with provisions of any applicable guidelines of donor agencies, or any other applicable Statute / Law or Rule enforced at the time in Pakistan, the provisions of such applicable guidelines, laws, or rules shall prevail. This SOP shall become a part of the future Bidding Documents.

**3 DEFINITION OF TERMS**

- 3.1 "Appellate Authority" - Authority to Appeal against issuance of Blacklisting Order.
- 3.2 "Appeal" - Right of firm/individual to lodge protest against the issuance of Blacklisting Order.
- 3.3 "Procuring Agency" - Any department/division/factory/project exercising general and/or administrative control over the unit.
- 3.4 "Blacklisting Order" - An administrative penalty disqualifying a firm/individual from participating in procurement for a given period.
- 3.5 "Suspension" - The administrative penalty imposed for infractions committed during the competitive bidding stage, whereby such firms/individuals are prohibited from further participation in the bidding process of Procuring Agency.
- 3.6 "Contract Implementation" - A process of undertaking a project or contract in accordance with the contract documents.
- 3.7 "Termination of Contract" - Extinction of contract by reason or resolution or rescission under applicable rules/regulations/laws arising from the default of the firms/individuals.
- 3.8 "Delist" - Removal of supplier/contractor from blacklisting.
- 3.9 "PA-Project Authority" - A three-member committee comprising of User, HSE&QA & Procurement Deptt. to address the issue.
- 3.10 RPC-SSG's Rights Protection Committee - To examine the justification of PC.

Page 1 of 10  
Dated : 12<sup>th</sup> October 2020  
Revision-1 : Dt: 3 Sept 2024

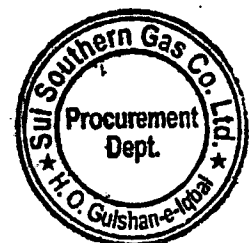

#### 4. REASONS FOR BLACKLISTING

4.1 The following shall comprise the broad multilateral guidelines for blacklisting:

- 4.1.1 "Corrupt Practice" means the offering, giving, receiving, or soliciting, directly or indirectly, of anything of value to influence the action of a public official in the procurement process or in contract execution;
- 4.1.2 "Fraudulent Practice" means a misrepresentation or omission of facts in order to influence a procurement process or the execution of a contract;
- 4.1.3 "Collusive Practice" means a scheme or arrangement between two or more bidders, with or without the knowledge of the Purchaser, designed to establish bid price at artificial, non-competitive levels, and
- 4.1.4 "Coercive Practice" means harming or threatening to harm, directly or indirectly, Person(s) / Firm(s) or their property to influence their participation in the procurement process or affect the execution of a contract.

4.2 In addition to above, blacklisting of firms/individuals may be resorted to when the charges are of serious nature, which include but are not limited to the following:

##### 4.2.1 Competitive Bidding Stage

During the competitive bidding stage, the Procuring Agency shall impose on bidders or prospective bidders the penalty of Suspension from participating in the public bidding process, without prejudice to the imposition of additional administrative sanctions as the internal rules of the agency may provide and/or further criminal prosecution, as provided by applicable laws, for violations committed which include but are not limited to the following:

- i. Submission of eligibility requirements containing false information or falsified documents.
- ii. Submission of bids that contain false information or falsified documents, or the concealment of such information in the bids in order to influence the outcome of eligibility screening or any other stage of the public bidding.
- iii. Submission of unauthorized or fake documents for pre-qualification/ tendering i.e. without specific authorization from the principals/ manufacturers etc.
- iv. Failure of the firm to provide authentic Warranty Undertaking and Performance Invoice of the manufacturers / Principal / Trading house.
- v. Failure of the firm to submit specific authority letter of the Original Equipment Manufacturer (OEM) for participation in a particular tender;
- vi. Unauthorized use of one's name, or using the name of another for purpose of public bidding.
- vii. Deviations from specifications and terms & conditions of the purchase order/contract.
- viii. Withdrawal of a bid, or refusal to accept an award or refusal to perform the job or enter into contract with the government without justifiable cause, after he had been adjudged as having submitted the Lowest Calculated Responsive Bid or Highest Rated Responsive Bid.
- ix. Refusal or failure to post the required performance security within the prescribed time.
- x. Refusal to clarify or validate in writing its Bid during post qualification within a period of seven (7) working days, or as may be specifically prescribed, from receipt of the request for clarification.

Page 2 of 10

Dated : 12<sup>th</sup> October 2020

Revision-1 : Dt: 3 Sept 2024

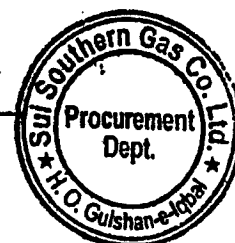

- xi. Any documented unsolicited attempt by a bidder to unduly influence the outcome of the bidding in his favor.
  - xii. Any attempt to give illegal gratification to any representative of the purchaser to influence the process of procurement.
- In addition to the penalty of suspension, the bid security posted by the concerned bidder or prospective bidder could also be forfeited / encashed.

#### 4.2.2 Purchase Order / Contract Implementation Stage

During the Purchase Order / Contract implementation stage, the procuring entity shall impose on contractors after the termination of the contract the penalty of suspension from participating in the public bidding process, without prejudice to the imposition of additional administrative sanctions as the internal rules of the agency may provide and/or further criminal prosecution, as provided by applicable laws, for violations committed which include but are not limited to the following:

- i. Failure of the contractor, due solely to his fault or negligence, to mobilize and start work or performance within the specified period in the Letter to Proceed.
- ii. Failure by the contractor to fully and faithfully comply with its contractual obligations without valid cause, or failure by the contractor to comply with any written lawful instruction of the Procuring Agency or its representative(s) pursuant to the implementation of the contract. For the procurement of infrastructure projects or consultancy contracts, lawful instructions include but are not limited to the following:
  - a. Employment of competent technical Person(s) / Firm(s)nel, competent engineers and/or work supervisors;
  - b. Provision of warning signs and barricades in accordance with approved plans and specifications and contract provisions;
  - c. Stockpiling in proper places of all materials and removal from the project site of waste and excess materials, including broken pavement and excavated debris in accordance with approved plans and specifications and contract provisions;
  - d. Deployment of committed equipment, facilities, support staff and manpower; and
  - e. Renewal of the effectivity dates of the performance security after its expiration during the course of contract implementation.
  - f. Non-Performance of the supplier in respect of tender terms & conditions and the delivery / supply of material.
- iii. Assignment and subcontracting of the contract or any part thereof or substitution of key Person(s) / Firm(s)nel named in the proposal without prior written approval by the Procuring Agency.
- iv. For the procurement of goods, unsatisfactory progress in the delivery of the goods by the manufacturer, supplier or distributor arising from his fault or negligence and/or unsatisfactory or inferior quality of goods, as may be provided in the contract.
- v. For the procurement of consulting services, poor performance by the consultant of his services arising from his fault or negligence, any of the following acts by the consultant shall be construed as poor performance:
  - a. Defective design resulting in substantial corrective works in design and/or construction;
  - b. Failure to deliver critical outputs due to consultant's fault or negligence;
  - c. Specifying materials which are inappropriate, substandard or way above acceptable standards;



- d. Allowing defective workmanship or works by the contractor being supervised by the consultant; and
  - e. Submitting CV's of key Person(s) / Firm(s) in the prequalifying process or bid documents of professionals that are not in actual employment of the bidder.
- VI. For the procurement of infrastructure projects, poor performance by the contractor or unsatisfactory quality and/or progress of works arising from his fault or negligence.
- vii. Willful or deliberate abandonment or non-performance of the project or contract by the contractor resulting to substantial breach thereof without lawful and/or just cause.

In addition to the penalty of suspension, the performance security posted by the contractor could also be forfeited.

4.2.3 In addition to above, other grounds for blacklisting of firms/individuals include but are not limited to the following:

- i. Obtaining fraudulent payments;
- ii. Obtaining contracts by misleading the purchaser;
- iii. Refusal to pay SSGC dues etc.;
- iv. Failure to fulfill contractual obligations;
- v. Changes in the status of firm's ownership/partnership etc, causing dissolution of the firm which existed at the time of inspection / bidding prior to original registration of the firm;
- vi. Registration of a firm with a new name by the Proprietor or family or a nominee thereof of a firm that has been already blacklisted;
- vii. Consequential operational damages caused to SSGC equipment or infrastructure as a result of equipment or parts thereof supplied on trial basis or due to failure of such equipment;
- viii. Contractors who have negotiated Plea Bargain under the National Accountability Ordinance 1999, or contractors involved with any other criminal proceedings conducted by any investigation agency where default has been proved specifically in relation to supplies made to or contracts concluded with SSGC.
- ix. Involved in litigation or needless petitioning to influence or obstruct the procurement process either on his own behalf or at the behest of any other vested interest;
- x. A firm may be disqualified for a period extendable to two years in case a decision by a court is awarded against the said firm after litigation, or where the firm is involved in litigation at least three times during two financial years, or where a firm has on account of litigation caused substantial financial losses to SSGC;
- xi. Blacklisted by other Federal and Provincial Government Ministries / Divisions / Departments and organizations / autonomous bodies subordinate thereto; and
- xii. Blacklisting in case of Joint Venture firms will also result in termination of the concerned Joint Ventures Partners.

## 5. SYSTEM OF PENALTIES

For the purpose of uniformity, following system of penalties shall be adopted for procurement of goods, works and services:

- 5.1 Blacklisted and henceforth cross debarred for participation in any public procurement or disposal proceedings for the period of not more than ten years, if corrupt and fraudulent

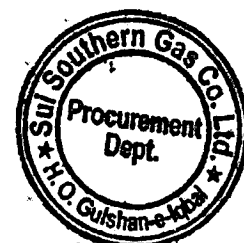



practice as defined in these rules is established against the bidder or the bidders in pursuance of blacklisting proceedings:

- 5.2 blacklisted and henceforth cross debarred for participation in respective category of public procurement or disposal proceedings for a period of not more than three years, if the bidder fails to perform his contractual obligations during the execution of contract or breaches the contract due to his capacity and capability to perform or otherwise. However, procuring agency shall initiate such blacklisting or debarment proceedings after exhausting the forum of arbitration, provided that such provision exists in the conditions of contract, and if such failure or breach is covered in the respective dispute settlement clauses of the contract, and
- 5.3 blacklisted and henceforth cross debarred for participation in respective category of public procurement or disposal proceedings for a period of not more than six months, if the bidder fails to abide with a bid securing declaration, however without being indulged in any corrupt and fraudulent practice.

## 6. SUSPENSION AND BLACKLISTING PROCEDURE

1. The supplier or contractor who is to be blacklisted for a specified period is given adequate opportunity of being heard.
2. The supplier or contractor who is to be blacklisted for a specified period is called for meeting by providing adequate time, so as to given him adequate opportunity of being heard before taking any action.
3. In case the supplier or contractor does not attend the meeting on the given date and time a final notice is served to him / her to attend the meeting on the revised date and time. Despite the final notice, if the supplier or contractor does not attend the meeting as per schedule, automatically be considered at fault. Action will be taken as per below clauses 5 to 9.
4. A three-member committee will form comprising of User, Procurement and HSE&QA departments to address the issues in the meeting with the supplier or contractor. Members of committee may not below of grade IV.
5. In case the supplier or contractor is found at default based on the fact of the case as well as the tender terms and conditions, and do not justify the grounds of his default as per the tender terms and conditions, the approval is sought from the management for their temporary or permeant blacklisting alongwith encashment of bid bond or PBG as the case may be.
6. The decision of the management is communicated to the defaulted supplier or contractor through a formal letter.
7. A copy of the letter of the defaulted supplier / contractor alongwith covering letter with pertinent documents is / also forwarded to the Authority (PPRA) for uploading on PPRA website.
8. The blacklisting information of the supplier / contractor is uploaded on the websites.

Page 5 of 10  
Dated : 12<sup>th</sup> October 2020  
Revision-1 : Dt: 3 Sept 2024



9. Any bidder not satisfied with the decision of the procuring agency, may lodge an appeal in the relevant court of jurisdiction.
10. After coming into force the procurement contracts, the dispute between the parties to the contract shall be settled by arbitration.

## 7. STATUS OF BLACKLISTED FIRM/INDIVIDUAL

Blacklisting of a firm/individual will not affect other ongoing contracts/works/supply orders. However, such blacklisted firm shall stand barred from all future tender processes/participation and Standing Security, if any, could be confiscated until recovery of financial damages ascertained by the authority while issuing Blacklisting Order.

## 8. DELISTING

A temporary blacklisted firm / individual shall be automatically restored after the period for the penalty has elapsed, unless the procuring agency wants to maintain the blacklisted status of firm / individual due to justifiable reasons with the prior approval of Appellate Authority. In the latter case, the temporary blacklisted firm / individual shall be restored.

## 9. AMENDMENTS

- 9.1 In the implementation of Blacklisting Mechanism, the modifications may be introduced thereto through the amendment of its specific provisions as the need arises.
- 9.2 Any amendment to this Blacklisting Mechanism shall be applicable to tenders advertised for bid after the effectivity of the said amendment.

## 10. EFFECTIVITY

The Blacklisting Mechanism or any amendments thereof shall take effect immediately and from the date of its issuance. All future tender documents must be governed by these instructions. However, these cannot override the provisions of Public Procurement Rules, 2004.

## 11. The Steps to be Followed are As Under

The causes and reasons to be taken into consideration for Debarment / Blacklisting of any Person(s) / Firm(s) are given as under:

### 1. PRE-AWARD STAGE:

The following shall be considered, inter alia, the events / reasons for initiating proceedings under this Mechanism at the Pre-Award Stage:

- i Indulging in Corrupt: Fraudulent as well as Collusive practices.
- ii Submission of false and spurious documents, making false statements, making frivolous complaints and allegations to gain undue advantage.

- Page 6 of 10  
Dated : 12<sup>th</sup> October 2020  
Revision-1 : Dt: 3 Sept 2024

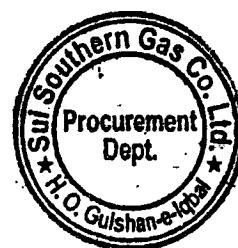

- iii Commission of embezzlement, criminal breach of trust, theft, cheating, forgery, bribery, falsification or destruction of records, receiving stolen property, false use of trademark, securing fraudulent registration, giving false evidence, furnishing of false information of serious nature.
- iv Submission of false bid security or infringement of documents to get undue monetary or any other benefit.
- v Breach of confidentiality of evaluation process based on illegal access or in any way to get undue benefit or to provide benefit or to frustrate the bidding/evaluation process. This will also include attempts to sabotage the bidding process directly or indirectly.

## 2. POST- AWARD STAGE:

The following shall be considered, inter alia, the events / reasons for initiating proceedings under this Mechanism at the Post-Award Stage:-

- i. Extraordinary delay in signing or refusal to accept the Notification of Award and/or the contract without any cogent reason.
- ii. Misconduct, i.e., failure to proceed with the signed contract, withdrawal of commitments, quoting an unreasonably and unfairly low financial offer and subsequently withdrawing such an offer, frustrating the evaluation/bidding process and not responding to written communication in a reasonable time.
- iii. Causes mentioned in Sub-Clauses i, ii and iii above.
- iv. Submission of fake / frivolous or mutilated Performance Guarantee or Advance Payment Guarantee etc.
- v. Non-satisfactory performance during the execution of the contract / purchase order.
- vi. Non-performance or Breach of provisions / clauses of the contract agreements/tender terms.
- vii. Notwithstanding the warranty/defect liability period, any defect in a product, equipment, plant, facility or services rendered that may subsequently surface during field operations within 5 years of its commissioning.
- viii. Failure to honour obligations within warranty period or defect liability period as defined in the contract.

## 3. OTHER CAUSES :

- i. The Person(s) / Firm(s) is blacklisted by any Government department in Pakistan, or it is established that the firm is involved in any kind of corruption or corrupt practices anywhere in the world.
- ii. Violations of provisions / instructions set down in the Bidding Documents.

Page 7 of 10  
Dated : 12<sup>th</sup> October 2020  
Revision-1 : Dt: 3 Sept 2024

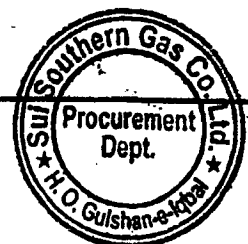

- iii. Any attempt / activity to malign or bring SSGC into disrepute and harm its interest(s).
- iv. Person(s) / Firm(s)(s) blacklisted by International Financial Institutions (donor agencies) will be liable to be blacklisted after receipt of confirmation from the donor agencies without any further proceeding.
- v. Any other cause deemed just and appropriate by CPPA in the given circumstances.

Note: (1) If above mentioned causes occur either on part of the principal bidder or the local agent, both shall be considered for blacklisting / debarment.

- (2) The authorization of the foreign bidder to local agent shall contain his complete particulars including the name of the company, name of the owner, National Tax number (NTN), CNIC (Computerized National Identity Card) No. etc. In case, the said information is found to be missing, even after calling for the same within a reasonable time, the authority letter shall not be accepted.
- (3) The Bidding Documents shall be issued against original authority letter or in case of scanned copy, the email of the foreign bidder shall be enclosed. However, at the time of bidding, the original authority letter shall be attached with the bid. In the absence of the same, the bid shall be rejected.

4. **FORMULATION of SSGC's Rights Protection Committee:** A permanent Committee namely "SSGC's Rights Protection Committee (RPC or Committee)" shall examine the justification of the reasons given by the Project Authority prior to blacklisting. Member of RPC must be one grade up from the members of PA.

#### 5. PROCEDURE FOR BLACKLISTING

Upon receipt of or obtaining information and/or knowledge that any Person(s) / Firm(s)(s) is involved in practices mentioned in hereinabove under the heading of Pre-Award Stage, Post-Award Stage and Other Causes, the concerned Project Authority / formation shall promptly formulate its recommendations and submit through the Managing Director, SSGC to SSGC's RPC / Committee along with its findings, details of charges and documentary evidences to initiate proceedings under this Mechanism.

#### 6. INITIATION OF AN ACTION

- (i) Within a period of 15 days after receiving the recommendations of Blacklisting / Debarment from the concerned Project Authority, the Convener of the Committee shall issue a Show Cause Notice ("Notice") thereby informing the Person(s) / Firm(s) about the alleged charges and shall provide an opportunity to the defend said charges within a time period of 15 (fifteen) days.
- (ii) The Person(s) / Firm(s)(s) shall be accorded adequate opportunity of hearing in order to defend the charges within the given timelines.
- (iii) The Notice to the Person(s) / Firm(s) shall be sent at the mailing/postal address as provided under the Contract or any other address provided by way of subsequent written communication by the Person(s) / Firm(s). The non-receipt of the Notice due to incorrect / change in mailing address without any written communication shall not be attributable to

Page 8 of 10  
Dated : 12<sup>th</sup> October 2020  
Revision-1 : Dt: 3 Sept 2024

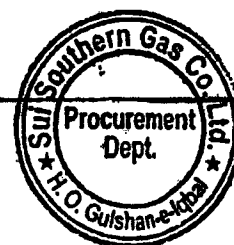

SSGC. In case of non-receipt of any reply from the accused Person(s) / Firm(s) within the formulated time, but not less than the time given in (i) above, the Committee shall have the right to proceed on Ex-parte basis.

## 7. DECISION

The committee shall hold an independent inquiry/investigation as the case may be, and, which may include site visits and interviews with the parties concerned. The Committee shall complete the entire inquiry/investigation, preferably within a period of 30 days after receipt of response from the Person(s) / Firm(s) against whom proceedings under this Mechanism has been initiated and shall present the report to the Managing Director, SSGC. If required, the Committee may report the case to an appropriate law enforcement agency depending upon the nature of the case for detailed investigations with the prior approval of Managing Director, SSGC. iii. The Person(s) / Firm(s) against whom proceedings have been initiated under this Mechanism shall not proceed for arbitration/litigation during the proceedings for blacklisting.

## 8. COMMUNICATION OF DECISION

After recommendation for temporary & permanent blacklisting by "SSGC's Rights Protection Committee (RPC)", the Person(s) / Firm(s) concerned shall be informed within 10 days of such decision. The decision of the Committee will be notified on SSGC 's and PPRA's websites and shall also be conveyed to Pakistan Engineering Council.

The temporary Blacklisting on the grounds and reasons specified herein above shall be for a reasonable specified period of time and as a general rule of prudence, the period may not exceed three years, except in cases where debarment/blacklisting has been done by any other government department or an International Financial Institution (Donor Agency). In case the Person(s) / Firm(s) has been blacklisted by the government department or the International Financial

Institution (donor agency), the period of temporary blacklisting/debarment shall be for a maximum period of 3 years or the time period for which the concerned government department/International Financial Institution (Donor Agency) debarred the contractor (whichever is higher). However the permanent blacklisting cannot be revived.

Action after the Person(s) / Firm(s) are placed on Blacklisting List:

- i. The decision of blacklisting will be immediately circulated to all concerned as mentioned herein above under the heading Communication of Decision.
- ii. In case of a contract already awarded to a Person(s) / Firm(s) which has been blacklisted and termination is either not possible or not feasible, the concerned Project Authority may proceed in this case to complete the contract with the approval of Competent Authority: (iii) The blacklisted Person(s) / Firm(s) shall stand disqualified from bidding from the date of decision against them. Any pending bids shall also stand rejected. If a contract has already been awarded to Person(s) / Firm(s), it shall be voidable at the option of SSGC. (iv) A separate register or data base will be maintained for blacklisted firms indicating reasons and period.

Page 9 of 10  
Dated : 12<sup>th</sup> October 2020  
Revision-1 : Dt: 3 Sept 2024

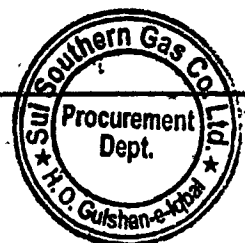

9. Effectiveness

This Mechanism or any amendments thereof shall take effect immediately with the approval from Managing Director of Sui Southern Gas Company Limited.

Not for Bidding Purpose

Page 10 of 10  
Dated : 12<sup>th</sup> October 2020  
Revision-1 : Dt: 3 Sept 2024





**Sui Southern Gas  
Company Limited**  
*Health, Safety, Environment & Quality Assurance*

# HSE&QA AWARENESS FOR SUPPLIERS AND CONTRACTORS (Revised in 2023)



**Always be proactive about safety!**

**Report Hazard before it results in an Accident**

**If it's UNSAFE!**

- ✓ Report it
- ✓ Remove it
- ✓ Replace it

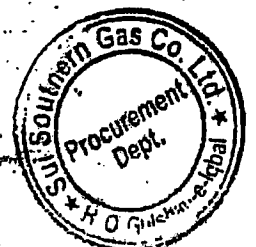

MP

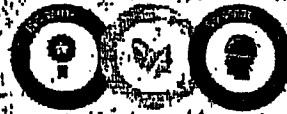

Sui Southern Gas  
Company Limited.

## HSE & QA-IMS POLICY

SSGC is committed to the Health and Safety of all its Employees & Stakeholders, preservation of Environment and achieving Operational excellence by improving Quality of products / services along with efforts to promote Safety Culture in the Company. Continual improvement of HSE and QA performance by reducing potential hazards to prevent injuries and illness is our key priority. It also includes communication, consultation and participation on HSE and QA objectives and targets with stakeholders, conserving resources and adhering to applicable Laws and Regulations in all activities / processes related to the Transmission and Distribution of natural gas within its franchise area.

  
Managing Director  
August 2021



MR



## 1. PURPOSE

The purpose of this procedure is to identify the context of the organization, assess the risks and opportunities and establish controls associated with all the activities undertaken by the company to address risks and opportunities for:

- a. SSGC existing facilities/installations.
- b. Any routine/non-routine activity, performed within permanent locations or outside permanent locations of SSGC, that requires prior permit/safety analysis to identify and mitigate safety risks.
- c. Any new project.
- d. Covering all the activities performed by SSGC taking into consideration of compliance, obligations, risks & opportunities within the scope, external and internal issues related to scope of operations, requirements, information, needs and expectations of relevant interested parties.
- e. Providing guidance to employees in relation to hazard identification, risk assessment and risk control in respective areas.
- f. Identification, control, monitoring and management of environmental aspects and assessment of its impacts.



## 2. SCOPE

This procedure is applicable to the identification of occupational health and safety hazards and associated risks, environmental aspects and impacts associated with activities, processes and equipment related to SSGC existing facilities/installations, any new project or any routine/non-routine activity, performed within permanent locations or outside permanent locations of SSGC, that requires prior permit/safety analysis to identify and mitigate occupational health and safety risk.

## 3. DEFINITIONS & ACRONYMS

- a. **HAZARD:** Source or situation with a potential for harm in terms of injury or ill health, damage to property, damage to workplace environment, or a combination of these.
- b. **RISK:** Combination of probability of occurrence of a hazardous event or exposure and the resulting consequences.
- c. **OPPORTUNITY:** Opportunities can arise as a result of a situation favorable to achieving an intended result, for example, a set of circumstances that allow the organization to attract customers, develop new products and services, reduce waste or improve productivity. Actions to address opportunities can also include consideration of associated risks.
- d. **SWOT:** Strength, Weakness, Opportunity & Threat.
- e. **RISK MANAGEMENT:** The set of control measures used to reduce or eliminate specific risk.
- f. **RISK ASSESSMENT:** Risk Assessment is a systematic approach to hazard identification. This is the overall process of estimating the priority of risk and deciding significance of risk.
- g. **RISK ASSESSMENT METHODOLOGY:** Risk priority shall be defined by the risk assessment matrix. Hazards related to applicable legal requirements will fall in the high risk category.
- h. **HIRA:** Hazard Identification and Risk Assessment.
- i. **EAIA:** Environmental Aspect and Impact Assessment.
- j. **IEE:** Initial Environment Examination.
- k. **EIA:** Environment Impact Assessment.
- l. **ILL HEALTH:** Identifiable, adverse physical or mental condition arising from and/or made worse by a work activity and /or work related situation.
- m. **OHS&E:** Occupational Health, Safety & Environment.
- n. **PTW:** Permit to Work.
- o. **MOC:** Management of Change.
- p. **MOC Owner:** The employee who initiates the MOC.
- q. **JSA:** Job Safety Analysis.
- r. **EXECUTING DEPARTMENT:** It refers to the department performing the work or is responsible to get the work done through contractor.

MR

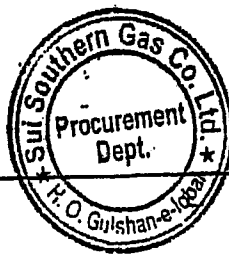

**4. RESPONSIBILITIES**

**4.1 Corporate HSE&QA In-charge**

- a. Managing OHS&E risks and their controls.
- b. Reporting to Senior Management on OHS&E related issues.
- c. Providing support to corporate HSE&QA team and zonal representatives.
- d. Liaise with zonal HSE team leaders/HSE&QA representatives for implementation of this procedure.

**4.2 Zonal HSE team leaders**

- a. Carrying out HIRA, providing and utilizing resources to identify and review OHS&E risks and implementing their controls in consultation with corporate HSE&QA team.
- b. Ensuring that employees, contractors and visitors have sufficient knowledge related to OHS&E.
- c. Maintaining records of the OHS&E with the help of local HSE&QA team.
- d. Implementing this procedure. Liaise with corporate HSE&QA team if required.

**4.3 Zonal HSE&QA representative**

- a. Coordinating with Zonal HSE team leader for carrying out HIRA and EAIA in their zones.
- b. Liaise with corporate HSE&QA team and zonal HSE team leader for OHS&E.
- c. Reviewing/monitoring HIRA and EAIA in their zones and providing input on any changes.

**4.4 Departmental Head of Executing Department**

Acquiring PTW for any activity that requires prior permit to identify and mitigate safety risks.  
 Ensure implementation of JSA for job/activity performed outside SSGC permanent locations.

**4.5 Employees**

Participating in the identification and assessment of OHS&E risks when required by either Zonal HSE team leader or HSE&QA representative.

**4.6 Visitors & Contractors**

Identifying and reporting any risk or hazard at any location of SSGC. This also includes the worksites and SSGC temporary locations during project executions.

**5. DECISION MATRIX**

Type of Risk/Hazard Assessment	Methodology	Responsibility
HIRA	Periodic risk assessment of SSGC's existing facilities/installations such as Head office, Headquarters, Regional offices etc.	Zonal HSE team leader
PTW	On-site Risk assessment (for Permanent Locations) for any routine/non-routine activity that requires prior permit to identify and mitigate safety risks.	Departmental head/Contractor executing the task/activity requiring PTW
JSA	On-site Risk assessment (for Field Locations) for any routine/non-routine activity.	Departmental head/Contractor executing the field activity

MR

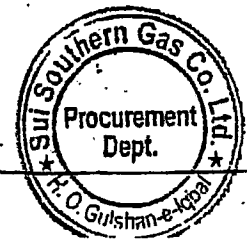

MOC	Risk assessments for new Projects, major changes or modifications in existing designs and infrastructure.	MOC owner
-----	---	-----------

Risk Assessment and Management Procedure is divided into five sections based on the type of risk assessment needed:

- Section 1: Context of the Organization.
- Section 2: Hazard Identification and Risk Assessment.
- Section 3: Permit to Work.
- Section 4: Job Safety Analysis.
- Section 5: Management of Change.

## 6. PROCEDURE

### Section 1 Context of the Organization

#### 6.1. Context of the Organization

- i. Management defines scope of the company services and its boundaries considering the internal and external issues of the organization.
- ii. In consultation with HSE&QA, Management & Zonal Heads identify external & internal interested parties and maintain its list with needs & expectations. Interested parties are those stakeholders who receive company services, who may be impacted by them, or those parties who may otherwise have a significant interest in the company. Interested parties may include:

Interested Parties	Requirements
Board of Directors	Good financial performance, legal compliance/avoidance of fines.
Law Enforcers/Regulators	Identification of applicable statutory and regulatory requirements for the products and services provided and understanding of the requirements.
Customers	Value for money; quality service, facilitation and quick response.
Bank/Finance	Good Financial Performance.
Employees	Professional development, prompt payment, health and safety, work/life balance, employment security.
Insurance	No claims/prompt payment/risk management.
Community	No complaint relating to: noise, parking, health and safety, pollution, waste.
External providers (Vendors/Suppliers)	Prompt payment as per agreed terms, health and safety, long-term working relationship.
Trade Unions	Compliance of local labor laws.

MR

- iii. By using SWOT analysis or any other tool, identify external and internal issues that are relevant to company operations and its strategic direction and that may affect the ability to achieve the intended result(s) of integrated management system. Internal and external issues can be positive or negative that can affect the OH&S management system.

**6.1.1. Internal Issues could include in risk & opportunity assessments, but are not limited to:**

- a. Operations spread in two provinces.
- b. Complex transmission and distribution network.
- c. Succession planning.
- d. Contractual relationships.
- e. Availability of reliable, qualified and competent workforce.
- f. Staff retention.
- g. Impact of unionization.

**6.1.2. External Issues could include in risk & opportunity assessments, but are not limited to:**

- a. **Political:** Government policies, political stability, international trade agreements etc.
- b. **Economic:** Fuel/utility prices, cash flow, credit availability, exchange rates, tariffs and inflation, general taxation issues etc.
- c. **Social:** Consumer buying pattern, education level, advertising and publicity, ethical & religious issues, demographics etc.
- d. **Technological:** Intellectual property issues, software changes, internet, technology legislation, associated/dependent technology, renewable energy etc.
- e. **Legal and regulatory:** Consumer protection, industry-specific regulation and permits, trade union regulations, employment law, international legislation, human rights/ethical issues etc.
- f. **Environment:** Customer demographics and environmental issues.
- g. **Government:** The directives from Prime Minister, Ministry of Petroleum (energy division), regulatory bodies like OGRA, SEPA & BEPA etc.
- d. Ensuring the policy and objectives are established for the integrated management system and are compatible with the context and strategic direction of the organization.
- e. The management shall monitor and review information about these external and internal issues during the management review meetings.

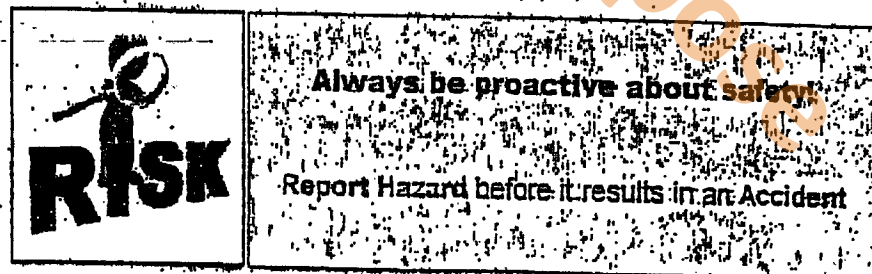

MR

## Section 2: Hazard Identification and Risk Assessment

### I. Hazard Identification and Risk Assessment

The Zonal HSE team leader in consultation with local HSE&QA representatives plan and initiate the HIRA and EAIA process. The assigned team must be competent and have enough knowledge of the entire process. Cross functional teams are recommended for such activity to cover all aspects during assessment. The record of OHS&E risk assessment is maintained in Hazard Identification & Risk Assessment Form (SSGC-IMS/CRM-F-01). The identification/assessment process shall take into account:

- a. Routine & non routine activities, any emergency situations.
- b. Activities of all persons having access to the SSGC permanent and temporary locations.
- c. Human behavior, capabilities and other human factors.
- d. Designing of work processes.
- e. Material in use.
- f. Infrastructure, equipment and materials at the workplace or project site, whether provided by organization or others.
- g. Changes or proposed changes in the organization, its activities or materials.
- h. Fabrication, installation & commissioning.
- i. Handling & disposal of waste material.
- j. Purchase of goods & services.
- k. Any applicable legal obligations that is related to risk assessment and implementation of necessary controls.
- l. Before commencement of any new operation/activity.
- m. Periodic Review for updating the existing hazard identification and risk assessment information.

#### At SSGC, we adapt five steps of risk assessment:

- Step 1: Identify the hazards.
- Step 2: Decide who might be harmed and how.
- Step 3: Evaluate the risks and decide on precautions.
- Step 4: Record your findings and implement them.
- Step 5: Review your risk assessment and update if necessary.

### ii. Risk Assessment Matrix

Risk assessment should be carried out as per assessment matrix below:

Risk Priority		Probability			
		Very Likely	Likely	Unlikely	Very Unlikely
Consequences	Catastrophic				Medium
	Significant			Medium	Medium
	Harmful		Medium	Medium	
	Negligible	Medium	Medium		

MR

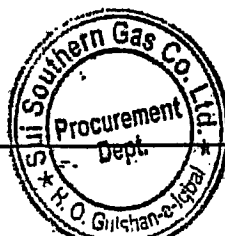

HAZARD CONSEQUENCE RATING TABLE	
Catastrophic	Hazard may cause death or total loss of one or more bodily functions. In case of failure a huge financial loss will occur.
Significant	Hazard may cause severe injury, illness or permanent or partial loss of one or more bodily functions (e.g. prolong exposure to asbestos resulting in Asbestosis or prolong exposure to paint fumes resulting in Chronic Lung Disorder), or serious property damage, loss that may result in disruption of SSGC core activities.
Harmful	Hazard may cause a reportable incident i.e. an incident that results in the employee being unable to undertake their normal duties and may need medical treatment, or property damage, loss that result in partial disruption of SSGC core activities.
Negligible	Hazard may cause minor injury, illness or property damage, first aid treatment is required only, very low financial loss.

PROBABILITY RATING TABLE	
Very Likely	Exposure to hazard likely to occur frequently. Similar incidents reported more than once in SSGC during last 10 years.
Likely	Exposure to hazard likely to occur but not frequently. Similar incidents reported once in last 5 years in SSGC.
Unlikely	Exposure to hazard unlikely to occur.
Highly Unlikely	Exposure to hazard so unlikely that it can be assumed that it will not happen.

RISK PRIORITY TABLE	
Risk Priority	Definitions of Priority
<b>High</b>	Situation is considered critical, stop work immediately or consider cessation of this operation/task. Must be fixed ASAP, Zonal HSE team leader should take immediate actions.
<b>Medium</b>	Is very important, must be fixed within two weeks, Zonal HSE team leader considers short term and/or long term actions.
<b>Low</b>	Is still important but can be dealt with through scheduled maintenance or similar type of action However, if solution is quick and easy then fix it immediately. Review and/or manage by routine procedures.

MR

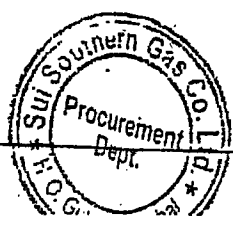

## Section 2 Hazard Identification and Risk Assessment

### iii. Risk/Impact Assessment Outputs

The output of risk/impact assessment may include the following:

- a. Identified operations of all hazards/aspects and risks/impacts associated with company activities/system etc.
- b. Classification of risk/impact.
- c. Description or reference to control the risks/impacts.
- d. Description or reference to monitor the risks/impacts.
- e. Identified competency and or training requirements.
- f. Input for setting improvement objectives and programs for its achievement.

The risk/impact measures identified shall include controls such as termination/elimination, treatment of the risk/impact and substitution of risk by suitable means and where required tolerated as long as it meets local laws/legislation.

Use output of risk/impact assessments as input for the following:

- a. Setting objectives and targets.
- b. Training needs identification.
- c. Terminating the risk/impact if it is practical.
- d. Facility engineering control.
- e. Emergency Preparedness.
- f. Administrative controls.
- g. Insurance.

The ultimate requirement is to reduce the risk/impact to a level as low as reasonably practical (ALARP) i.e. where the trouble, difficulty and cost for further reduction becomes unreasonably inconsistent to the additional risk reduction obtained.

### iv. Risk Control

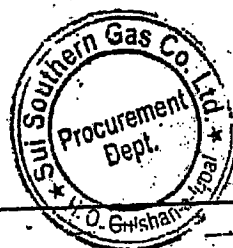
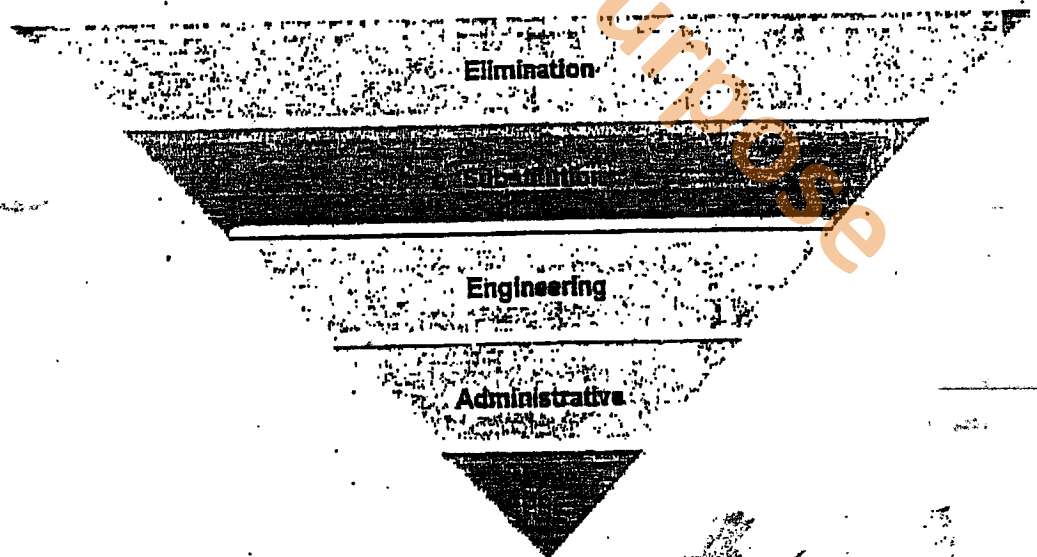

The hazards and risks are controlled through 'operational controls' by considering the following hierarchy.

- a. **Elimination:** The best way to control a hazard is to eliminate it. This can be achieved by making changes to the work process so that the task is no longer carried out, or by physically removing the hazard altogether. Elimination is the most effective way to control hazards and should be used whenever possible.
- b. **Substitution:** Substitution is the second most effective method for controlling hazards and risks. It is similar to elimination but involves the substitution of one higher priority risk by another lower priority risk.
- c. **Engineering:** Engineering controls are implemented by making changes to the design of an equipment or process to minimize its hazard. Engineering controls are based on the concept of "Doing it right the first time". Departments shall incorporate this concept during planning phase of any project/process and must seek out for best possible solution in terms of OHS&E.
- d. **Administrative:** Administrative controls involve making changes to the way in which people work and promoting safe work practices via education and training. Administrative controls may involve training employees in operating procedures, good housekeeping practices, emergency response in the event of incidents such as fire or employee injury, and personal hygiene practices.
- e. **Personal Protective Equipment (PPE):** Use of PPE will kick-off where no other controls stated above are possible. PPE should be properly identified for specific process/job.

System & work area Hazards	Likely Consequences
Access / Egress Obstructions	Minor injury, trips and falls
Asphyxiate Gas (CO <sub>2</sub> fire suppression)	Possible death by asphyxiation
Buried Cables	Exposure to buried cables - major / minor injury
Electricity (HV/LV)	Fatality by electric shock or serious burn injuries
Falling Loads / Objects	Serious head and / or body injury
Flammable Vapors / Gases / liquids	Explosion or fire
Flammable Materials	Potential for fire
Hot / Humid Work Environment	Heat stress, disorientation, loss of consciousness
Moving Parts	Entrapment, major or minor injury
Noise	Long term hearing loss, tinnitus
Openings in Floor / Walkways	Falls from height, major injury possible fatality
Flammable Materials / Gases	Creation of hazardous area, fire, explosion
Heat, sparks and naked flames	Burns to exposed skin
High Intensity light (welding)	Arc flash, short term discomfort, long term loss of vision
Housekeeping poor	Slip, trip, fall, fire hazards, blocking fire escapes
Lifting Operations	Falling or moving loads - serious head and / or body injury
Live Electrical Work	Fatality by electric shock or serious burn injuries
Lone Working	No emergency response if injured
Long Working Hours	Major / minor accident due to fatigue
Manual Handling	Muscular / skeletal injuries
New Task / Operation	Major / minor injury resulting from mistakes

MR

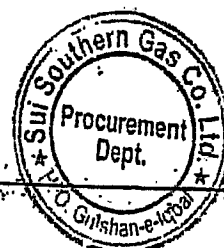



Oxygen deficiency	Death of asphyxiation
Poor Lighting / Visibility	Minor / major injury, fall or impact injury
Slipping / Tripping Hazards	Minor injury, trips and falls
Spillages (Oil and chemicals)	Land contamination
Substances hazardous to health	Chemical burns, toxic, poisoning, irritants, pollutant
Repetitive Task / Operation	Muscular / skeletal injuries
Rotating / Moving Part	Major injury, potential for fatality
Sharp Edges / Cutting Surface	Amputation and cuts, predominantly to hands
Smoke / Fume	Unconsciousness, respiratory problems
Trailing Cables and Hoses	Tripping hazard causing major / minor accident
Use of Hand Tools	Minor laceration and impact injuries
Use of Hazardous Substances	Burns to skin, eyes, and respiratory system. Environment Hazards
Use of Power Tools	Impact injury, hand / arm vibration - loss of sensation over time
Use of Workshop Equipment	Major / minor injuries - entrapment, cutting tools
Vibration	Hand / arm vibration - loss of sensation over time
Work at Height	Major / minor injury

**v. Environmental Aspect Identification & Impact Assessment**

**a. Environmental Aspects:**

An Environmental aspect is any element of SSGC business operation that negatively affect the Environment. While conducting environmental assessment, following aspects are usually considered:

**"REDUCE CARBON FOOTPRINT"**

What we can do:

- Recycle: what you can
- Reduce: avoid unnecessary consumption of resources
- Reuse: Buy items that are reusable and reuse them
- Unplug electrical devices that are not in use
- Avoid unnecessary driving
- Use LED bulbs
- Plant a tree

Emissions to air	Water Discharges
Solid non-hazardous waste	Solid Hazardous Waste
Consumption of natural resources/ Energy	Noise
Heat	Odor
Dust	Vibration
Effect on visual / aesthetics	Use of Ozone depleting substances
Use of radioactive / nuclear material	Spillage of chemicals

For identification of environmental aspects and impact, each process/activity/equipment is assessed for its inputs and outputs. The inputs can be raw materials, utilities, energy etc. The output can be atmospheric emissions, liquid effluents, noise, hazardous/non-hazardous wastes, vibration etc.

The inputs, outputs, environmental aspects, their associated impact and controls are recorded on Environmental Aspect & Impact Assessment Form (SSGC-IMS/CRM-F-02).

MR

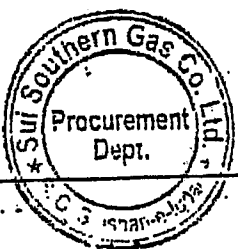

### b. Control of Aspects having Significant Environmental Impact:

The significant environmental risks require control measures to eliminate or reduce the impact to a tolerable level either by establishing objective or through application of controls by considering the 4R methodology i.e. Reduce, Reuse, Recover and Recycle.

Some of the suggested operational controls are listed below:

- a. Design of environmental friendly processes/operations,
- b. Isolation or enclosure of hazardous material storage, process or noisy equipment.
- c. Mechanical exhaust systems/booths for controlling toxic materials.
- d. Replacement of potentially unsafe equipment or machinery with new equipment/machines that meet environmental standards.
- e. Electrical or mechanical safety interlock, guards, indicators.
- f. Safety devices (Relieve valves, NRVs, indicators etc.), measuring or monitoring devices/gauges, computerized feedback monitoring and control systems.
- g. Environmental friendly disposal or treatment systems etc.
- h. Fire prevention/suppression systems.
- i. Containment walls.
- j. Scrubbers.
- k. Dust Collectors.
- l. Other controls: Training, SOP.

The record of operational controls on significant environmental risks is maintained on 'Environmental Aspect & Impact Assessment Form (SSGC-IMS/CRM-F-02).

After identification of aspects and assessment of impacts, it is sent to HSE&QA Department for reviewing adequacy and correctness. Where required, In-charge HSE&QA suggests necessary changes or improvement in risk assessment to concerned Zonal HSE Team Leader.

### c. Aspect & Impact Assessment Review & Monitoring:

Zonal HSE Team Leader ensures that environmental aspects and impacts related to the activities/processes/equipment are kept current by conducting the same assessment

- a. Once every six months to update the information, and identify new environmental aspects. (Use SSGC-IMS/CRM-F-02 for recording new hazards and aspects)
- b. Carry out assessment, for new or changes in activities/processes/equipment.
- c. When there is a change in laws & regulations.

### d. IEE (Initial Environment Examination) / EIA (Environment Impact Assessment):

In addition to all of above assessments, SSGC will carry out IEE / EIA as required by regulatory requirements for new projects. It is the responsibility of corporate HSE&QA head/DMD/MD to ensure the compliance for all new projects.



When combusted:

One liter of Diesel produces 2.68 kg of CO<sub>2</sub>

One liter of Petrol produces 2.31 kg of CO<sub>2</sub>

One MMBTU of Natural Gas produces 53.07 kg of CO<sub>2</sub>

MR

## Section 3 Permit to Work

### I. Permit to Work (PTW)

A Permit to Work (SSGC-IMS/CRM-F-03) is needed for any routine/non routine activity (Conducted within permanent locations of SSGC) where the work could expose persons to specific hazards. PTW should be acquired and maintained in the zones where job/activity is carried out. Normally following activities require PTW:

- a. Task based Hot Work operation such as welding, brazing, cutting, grinding.
- b. Confined space working. (tank cleaning etc.)
- c. Maintenance Work on High Voltage electrical equipment.
- d. Any janitorial service involving Safety Risks such as work at height.
- e. Any Maintenance activity by any department/contractor which compromises critical safety system.
- f. Work involving interaction with asbestos.
- g. Work in areas where there is a risk of exposure to hazardous chemicals or microorganisms.
- h. Any job/task/activity that requires additional precautions.
- i. Any specific activity performed during development, modification and up gradation of SSGC's Vital Installations including SMS/Valve Assembly/TBS/PRS etc.

### II. Exclusion

Following activities are not under the scope of PTW management, however the risk assessment, JSA and/or process SOPs are implemented to control the associated risks for the following:

- a. Providing Gas connections to new customers
- b. Emergency Response to Consumer calls (1199)
- c. Planned enhancement of Distribution network
- d. Work on live pipelines like hot tapping, installing Service Tee etc.
- e. Any major/minor rehabilitation/reinforcement work

**If it's UNSAFE!**

- ✓ Report it
- ✓ Remove it
- ✓ Replace it



MR

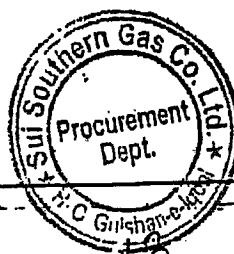

III. Responsibilities

S No.	Functions	Details	Responsibility
1	Executing Authority	The department intends to carry out the task / activity that requires PTW. Situation may arise where Executing Authority is same as Area Authority (e.g. HQs).	Fill out the PTW form. Ensures that task/activity is carried out according to the SOP and controls are implemented to ensure safe operations. Immediately report any incident happened during execution of job to In-charge HSE&QA.
2	Area Authority	Area/Facility where the task/activity is carried out.	Authorize PTW and verify the compliance during the execution of task/activity. Authorized to stop work in case of noncompliance to PTW requirements.
3	Contractor	The Individual/organization carrying out the Task/Activity on behalf of the executing department.	Liaise with executing department to ensure the controls are implemented as per requirement identified in PTW.
4	HSE&QA	HSE&QA will identify the risk/hazards associated with the activity/task and propose controls. In Zones where HSE&QA representatives are not present, Zonal HSE team leader will officiate for HSE&QA responsibilities.	If required, Monitor the task/activity during execution and identify any gaps related to proposed controls. Responsible to close the PTW and maintains records. Authorized to stop work in case of noncompliance to PTW requirements.

MR

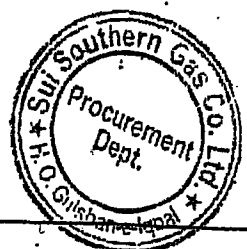

IV. PTW Process Flow

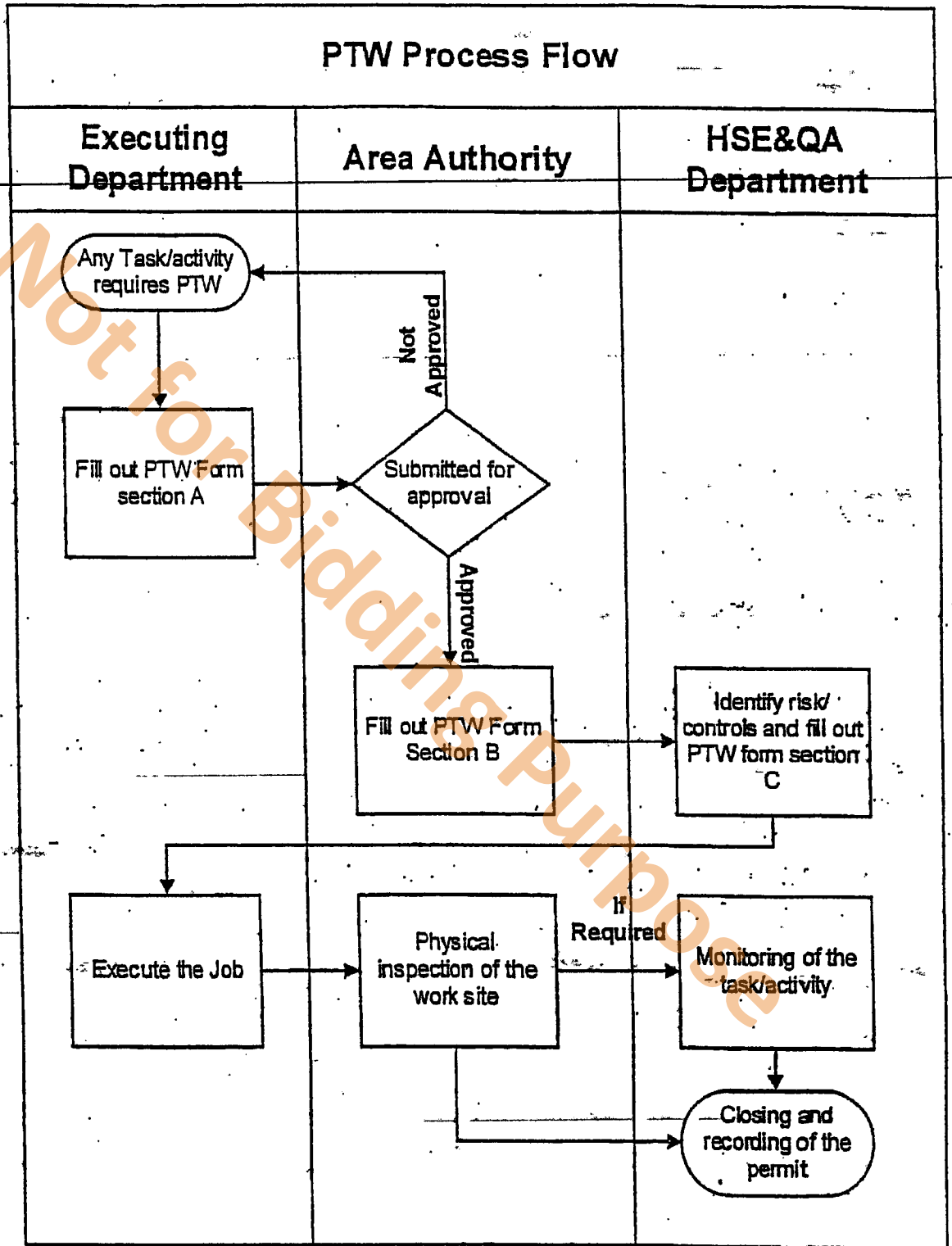

MR

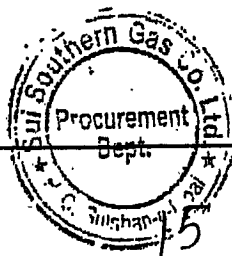

### V. Permit Display

Copy of the permit to work should be clearly displayed at the work site or in a location close to where the work activity is being undertaken. Executing department/contractors are also required to ensure that a copy of the permit to work is kept and made available upon request by Area Authority/ HSE&QA.

### Vi. PTW Closure

Once the task/activity is completed the PTW form is returned back to HSE&QA/Zonal HSE team leader for closing and updating the records. A new PTW is required if the task/activity is not completed within stipulated time frame mentioned on PTW.

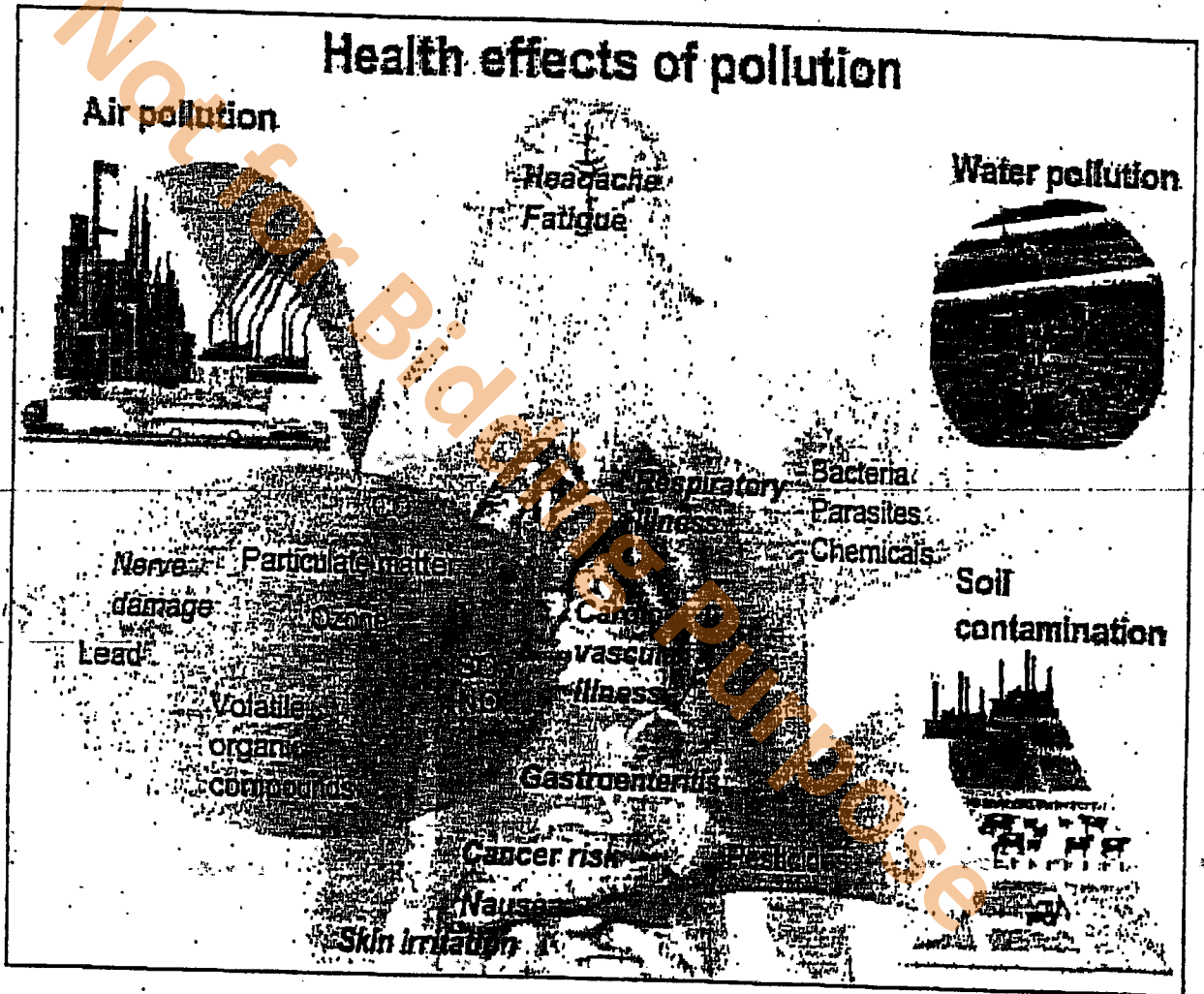

MR

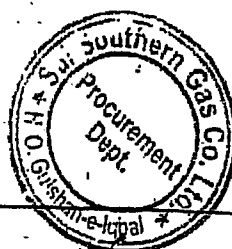

## Section 4 Job Safety Analysis

### I. Job Safety Analysis (JSA)

Job safety analysis is needed for any routine/non-routine activity (Conducted outside permanent locations of SSGC i.e. Field Locations) where the work could expose persons to specific hazards. Normally following activities require JSA (SSGC-IMS/CRM-F-04):

- a. Work on live pipelines like hot tapping.
- b. Any major/minor rehabilitation/reinforcement/maintenance work on existing distribution/transmission network.
- c. Installing service connection for new schemes. (Blanket JSA may be carried out for each scheme).
- d. Any Emergency maintenance work.
- e. Any particular job/activity requiring JSA as necessitated by HSE&QA.

### II. Responsibilities

S No.	Functions	Details	Responsibilities
1	Activity In-charge/ Supervisor	Individual who is assigned to carry out the task/activity requiring JSA.	<ul style="list-style-type: none"> <li>• List down the activities step wise and identify hazards and their controls</li> <li>• Ensure that task/activity is carried with proposed controls</li> <li>• Ensure the team/equipment involved are competent and safe</li> <li>• Report any untoward situation</li> </ul>
2	Head Of Executing Department	Head of the department who is authorizing the task/activity requiring JSA.	<ul style="list-style-type: none"> <li>• Authorize JSA</li> <li>• Ensure Adequate resources are provided to carry out the task/activity in safe manner.</li> <li>• Select competent team and team leader for the activity/task.</li> <li>• Submit a copy of JSA prior to job execution to HSE&amp;QA/Zonal HSE Team Leader.</li> </ul>
3	Contractor	The Individual / organization carrying out the Task/Activity on behalf of the executing department.	Liaise with executing department to ensure the controls are implemented as per requirement identified in JSA

MIR

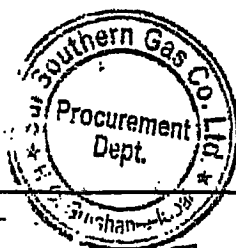

## Section 5 Management of Change

### I. Management of Change (MOC)

The purpose of this document is to provide all SSGC employees with instructions on Management of Change (MOC) process. Any changes that may affect quality, operations, safety, or the environment will be adequately assessed and must be approved by management or a designated representative of management prior to implementation.

Risk Assessment for any new project, major modification in existing design /facility/ installation will be carried out using MOC methodology.

### II. Scope

This procedure is intended to address those changes which may have a direct impact on SSGC's Integrated Management System, or the subsequent delivery of services.

To make sure that changes are assessed and documented in a consistent manner, so that:

- Unnecessary or counterproductive changes are prevented.
- Changes do not adversely affect safety, the environment, quality, operations, or the level of service to the client.
- No changes are made by individuals without knowledge and/or agreement of all relevant parties.
- A record of the assessment rationale and change assessment process is produced.
- To make sure proper change out of employees during operations is addressed.

### III. Responsibility

- MOC Owner:** MOC owner is responsible to fill out the designated section of the MOC form (SSGC-IMS/CRM-F-05) which briefly describe the details/scope of the project.
- Area Authority:** Area authority is responsible to identify the possible impacts of the change that is taking place. Generally geographical head/zonal HSE team leader is considered the area authority.
- HSE&QA Department:** HSE&QA Department is responsible to authorize the change after assessing the risk and their controls:

MR

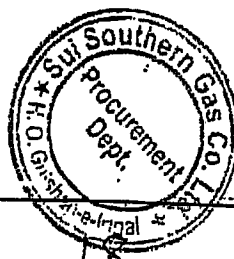



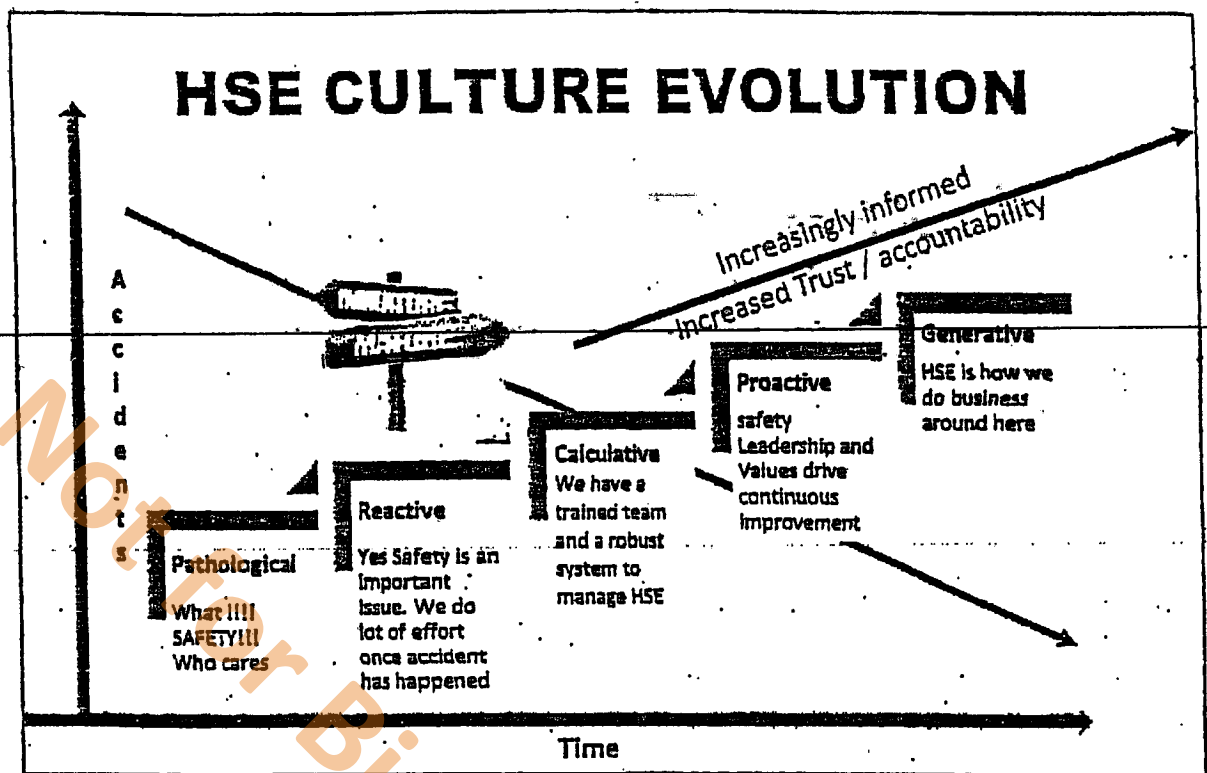

**IV. Definition of Change**

For the purpose of this procedure a "change" is an alteration to Processes;

- a. Documented information maintained by this IMS.
- b. Equipment, hardware, software, infrastructure.
- c. Personnel assignments and training.
- d. Vendor selection and management.

Other types of changes not listed above can be related to any element of the process, such as inputs, resources, persons, activities, controls, measurements, outputs, etc.

**Note:** Not all alterations to a system require the Management of Change Process (MOC) (e.g. changing employees, editorial changes to HSE & QA procedures and forms, etc.)

**V. Levels of Change**

**Level 1**

- a. Change which has limited or no effect on deliverables, operations, safety, work environment, etc.

**Level 2**

- b. Changes to equipment, procedures and employee assignments that have a moderate impact on deliverables, operations, safety, or work environment.

**Level 3**

- c. Changes to equipment, procedures and employee assignments that have a major impact on deliverables, operations, safety or work environment.

MR

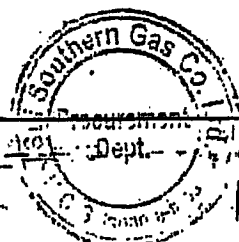

## VI. Change Procedure

### Step 1 – Initiation of Change

Any employee or contractor that becomes aware of a need for change can initiate the MOC process. The originator will notify their immediate Supervisor/Manager, detailing the proposed change on the MOC form (SSGC-IMS/CRM-F-05). With concurrence by their Supervisor / Manager, the MOC form shall then be forwarded to In-charge HSE&QA for review.

### Step 2 – Review by in-charge HSE&QA

In-charge HSE&QA will review the MOC request for potential operational impact, cost/benefit analysis, and associated risk, with input from the appropriate process owners (Moderate Impact) and/or SSGC top management (Major Impact), as appropriate to the change under consideration. Changes that have negligible impact may be processed by the Management Representative directly.

If the request is accepted, In-charge HSE&QA will detail any actions deemed necessary to control the impact of the change and forward the request to the appropriate process owner for implementation.

### Step 3 – Implementation of Actions

The process owner will be responsible for implementing and coordinating the actions required for the proposed change. If it is determined that further assessment is required during the course of implementing the change, these assessments will be documented and submitted for review prior to completing the change process. Only after all assessments have been reviewed shall the MOC process be continued and monitored through completion.

## VII. Closing out the MOC

The In-charge HSE&QA will review the satisfactory implementation of the proposed change, and effectiveness of any corresponding control measures.

## VIII. Record Keeping

The In-charge HSE&QA will retain a log showing each MOC (Control Number of Log) and file the initial MOC request (SSGC-IMS/CRM-F-05) with all information supporting the actions taken throughout the MOC process. These records shall be maintained for a minimum of 3 years.

MR

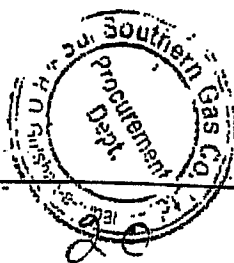

MOC Process Flow

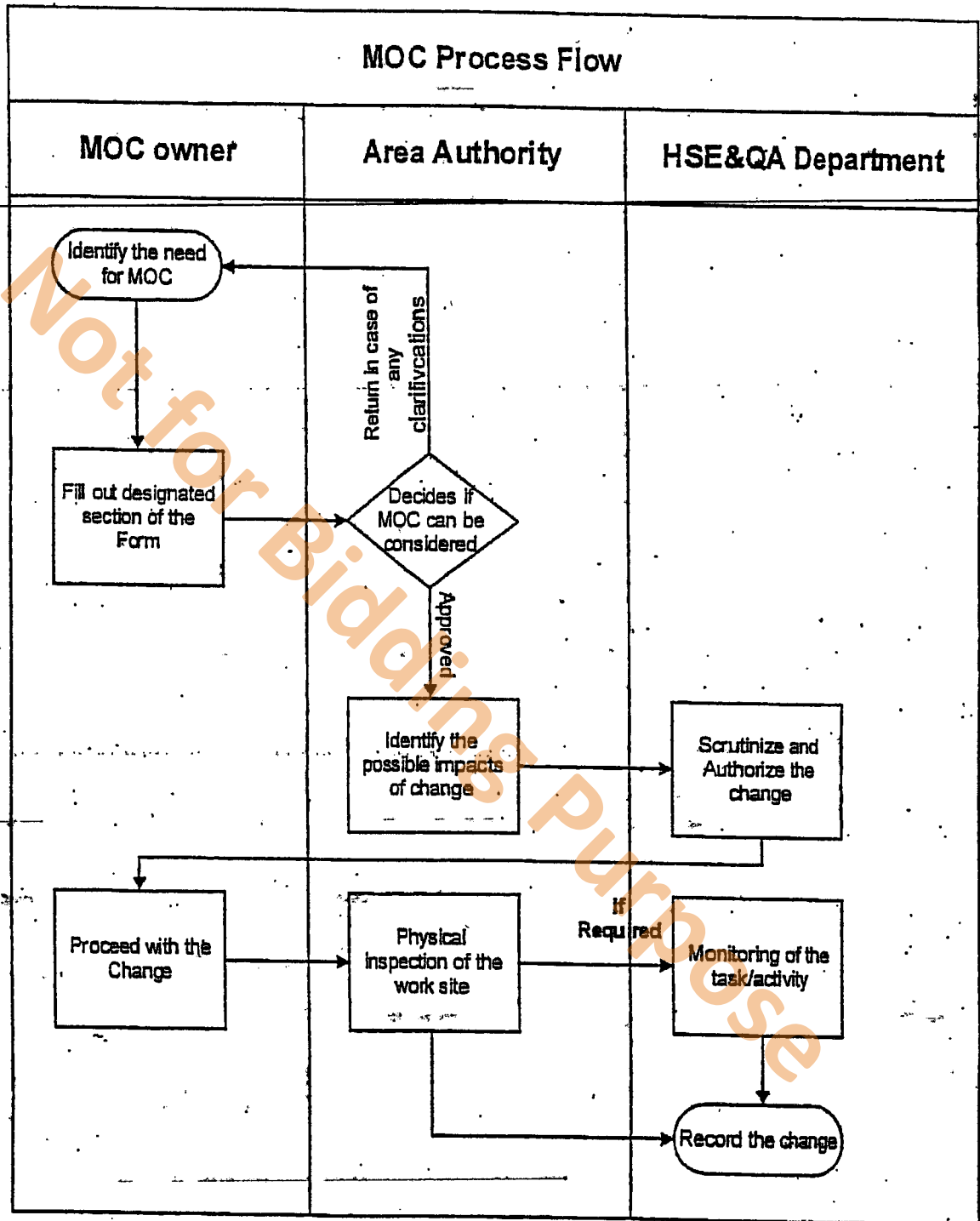

MR

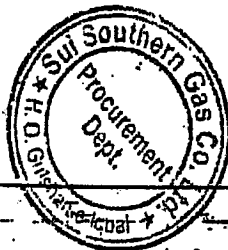

## 7. TYPICAL SSGC OPERATIONAL HAZARDS AND THEIR POSSIBLE CONTROLS

Some of the common Hazards related to SSGC operations are tabulated below and may be used while doing Risk assessment. There might be other hazards related to a particular activity/ operation or process. These hazards should be identified accordingly along with possible controls.

### 7.1. PHYSICAL

Hazards	Control Measures
Adverse weather	Shelter, personal protective equipment (PPE; cold / wind / rain-proof).
Poor / Bad housekeeping	Improved safety attitude, good management, safety inspection, good work layout.
Contact with hot / cold surfaces	Insulation, guarding, PPE (gloves, face shields, insulated clothing).
Drowning	Life guarding, lifesaving equipment, presence of first Aider.
Excavation work	Physical barriers; fencing, shoring, safe system of work, signs, caution tape.
Fail from height	Edge protection; safety lines / harnesses, safe means of access, (e.g. scaffolding), safe system of work (e.g. permit to work).
Fail of material from height	Alternative storage, physical means of securing.
Lighting	Good work area design and lighting equipment, measuring of illumination (LUX level), appropriate lighting.
Awkward lifting while laying pipes in trenches	Define weight limits, use mechanical means for lifting and laying of pipes.
Noise	Reduction at source, insulation, PPE.
Slips / Trips / Falls on same level	Good maintenance of work areas, good housekeeping, good cleaning, good footwear.
Stacking	Good work area layout, height limits, weight limits, strong packing, mechanical assistance.
Vibration	Elimination or reduction at source, damping, insulation, PPE.

MR

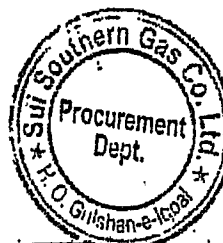

7.2. MECHANICAL

Hazards	Control Measures
Hand tools	Periodic inspection, electrical testing and maintenance.
Machines	Periodic inspection, testing and maintenance, physical barriers (guarding), safety interlocks, supervision and training.
Mechanical lifting operations	Periodic inspections, maintenance, supervision and training.
Manual handling	Regular assessment of handling techniques, improvisation to eliminate stress / fatigue, training in good lifting techniques.
Moving vehicles	Good road layout within premises, proper signs, vehicle maintenance, speed limit, enforce SSGC driving policy, defensive driving classes.
Over Pressure	Proper identification of pressure vessels, preventive maintenance, pressure indicators, alarms, PRV's where required, periodic inspection.

7.3. ELECTRICAL

Hazards	Control Measures
Live working	Avoid (i.e. No Live Working), use competent / trained staff.
Hand tools	Regular inspection, testing of electrical integrity and replacement (where appropriate).
Heaters (elements)	Isolate from combustible material, guarding.
Machines / Electrical cables	Electrical testing and maintenance, good electrical safety design, periodic inspection for design load vs. actual load, use of circuit breakers, lockout / tag out, anti-static materials, Use double insulation, proper grounding.
Electrical cables / cords	Use factory assembled cords, always use plugs, no naked wires.
Power Lines (Overhead / Buried)	Look out for signs, contact local utilities (i.e. WAPDA) for locations, stay at least 10 feet away from overhead lines, use proper PPE.

MR

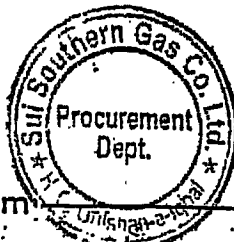

7.4. FIRE

Hazards	Control Measures
Combustible materials	Avoid, reduce storage of combustible materials, isolate from sources of heat and ignition.
Flammable gases	Storage of gas cylinders (e.g. hydrogen, acetylene) outside in an isolated, well-ventilated area; signs; no smoking, color-coding.
Flammable solvents	Controlled storage, use and disposal (e.g. limit quantities held), fire proof storage, signs, no smoking, no naked flames, emergency plans.
Heaters	Segregation from sources of combustion, guarding special construction if used in hazardous areas.
Oxidizing agents	Chemicals that are a source of oxygen, e.g. hydrogen peroxide, segregate from sources of combustion (e.g. flammable solvents).
Oxygen (gas and liquid)	Segregate from sources of combustion, controlled storage and usage.
Smoking materials	Designated smoking areas with proper ventilation, promote no smoking policy.
Static electricity	Limit use of static generators in hazardous areas. Use of anti-static devices, earthing.
Gas Leaks	Odourization for timely detection where possible, proper joining methods, Field survey, training, leak detection techniques.

7.5. OTHER

Hazards	Control Measures
<b>Chemical:</b> Chemical substances, Corrosives (acids, alkalis), Carcinogens, Irritants (e.g. Ammonia)	Avoid use, substitute less harmful substances, use, maintain and test engineering controls, monitor for hazardous substances, inform and train employees, use personal protective equipment (PPE), emergency plans for uncontrolled releases.
<b>Biological:</b> Biological agents (micro-organisms, pathogens, mutagens, carcinogens), Rodents, Snake Bite	Avoid use, substitute less harmful substances, use maintain and test engineering controls, monitor for hazardous substances, inform and train employees, use personal protective equipment (PPE), emergency plans for uncontrolled releases. Periodic rodent control drive, identification and elimination of snakes and other harmful reptiles specially in remote locations of SSGC.
<b>Food / Water safety</b>	Good food hygiene standards, good cleaning / disinfection, employee information and training, good personal hygiene, protective clothing. Testing if required from accredited lab (AKUH, PCSIR), involve canteen contractors, credibility of product/Services.
<b>Ergonomics</b>	Educate / Train employees, avoid repetitive tasks, procure ergonomically design products (e.g. chair, Computer desk).

MR

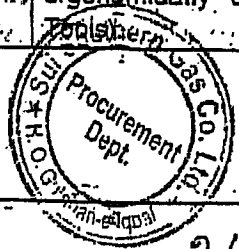

## 8. DOCUMENTED INFORMATION

Record No.	Record Name	Maintained by	Retention Period
SSGC-IMS/CRM-F-01.	Hazard Identification & Risk Assessment Form	HSE&QA Department	3 Years
SSGC-IMS/CRM-F-02	Environmental Aspect & Impact Assessment Form	HSE&QA Department	3 Years
SSGC-IMS/CRM-F-03	Permit to Work Form	HSE&QA Department	3 Years
SSGC-IMS/CRM-F-04	Job Safety Analysis Form	HSE&QA Department	3 Years
SSGC-IMS/CRM-F-05	Management of Change Form	HSE&QA Department	3 Years
SSGC-IMS/CRM-F-06	Context of the Organization	HSE&QA Department	3 Years
SSGC-IMS/CRM-F-07	SWOT Analysis	HSE&QA Department	3 Years

MR

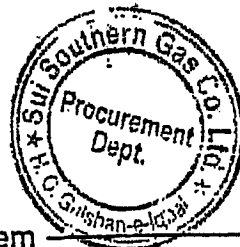

 <b>SSGC</b> HSE&QA Department	<b>IMS Form</b>	SSGC-IMS/CRM-F-01
	<b>Hazard Identification &amp; Risk Assessment Form</b>	
	Revision 01	
		Issue Date: July, 2021

Zone	Department	Location	Date				
S. No	Hazard (E.g. Warn out electrical cord)	What can go wrong (E.g. Electrical shock to any employee)	Existing Operational Control (E.g. Covered with plastic tape)	Risk Priority			Additional Operational Controls (E.g. Isolate/Replace the wire).
				PROBABILITY (E.g. Likely)	CONSEQUENCE (E.g. Significant)	PRIORITY (E.g. High)	
Additional Comments (If any):							
Zonal HSE Team Leader				HIRA Team			
Name & Designation		Signature		S. No	Name & Designation		Signature
				1			
				2			
				3			

MR

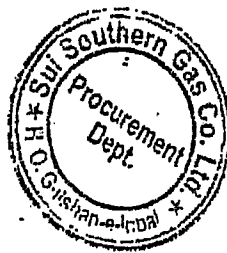



 <b>SSGC</b> HSE&QA Department	<b>IMS Form</b>	SSGC-IMS/CRM-F-02
	<b>Environmental Aspect &amp; Impact Assessment Form</b>	
		Revision 01
		Issue Date: July, 2021

Not for Binding Purpose

Zone	Department	Location	Date				
<b>Process / Operation Description: (E.g. Power Generation)</b>							
S.No	Activity (E.g. Fuel Combustion)	Input (E.g. fuel, air)	Output (E.g. Hydrocarbons, CO <sub>2</sub> , H <sub>2</sub> O, CO, particulate matters)	Environmental aspect (E.g. air emissions)	Environmental Impact (E.g. Degradation of air, consumption of natural resources, Depletion of ozone layer etc.)	Risk Priority (High/Medium/Low)	Operational controls
Additional Comments (If any):							
<b>Zonal Team Leader</b>				<b>EAIA Team</b>			
Name & Designation		Signature		S. No	Name & Designation		Signature
				1			
				2			
				3			

MIR

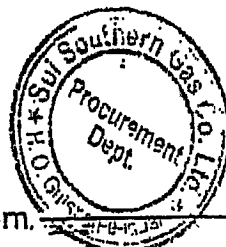

E-02

 <b>SSGC</b> HSE&QA Department	<b>IMS Form</b>	SSGC-IMS/CRM-F-03
	<b>Permit To Work Form</b>	
	Revision 01	
Issue Date: July, 2021		

Work Permit Number. (To be filled by HSE&QA):					
<b>Section "A"</b>					
To be filled by Executing Department	Department Name: _____		Contractor Details (If Any): _____		
	Responsible Person	Name: _____	Contact Name: _____		
		Signature: _____			Signature: _____
	Permit Valid From	Time: _____	Permit Valid Until		
Date: _____		Time: _____			
		Date: _____			
Location of the Work: _____					
Type of Work(s)			Detail of Work		
<input type="checkbox"/> Hot Work <input type="checkbox"/> Electrical maintenance work <input type="checkbox"/> Mechanical maintenance work <input type="checkbox"/> Hazardous chemicals <input type="checkbox"/> Working at height <input type="checkbox"/> Working in confined spaces <input type="checkbox"/> Working with compressed gases <input type="checkbox"/> Janitorial/Cleaning Service <input type="checkbox"/> Excavation/Trenching <input type="checkbox"/> Handling Asbestos <input type="checkbox"/> Lifting or hoisting <input type="checkbox"/> Other (Please provide details)					
Equipment/tools to be used: _____					
Please mention the associated hazards of this activity (Please refer IMS Procedure: Context, Opportunities & Risk Management): _____					
Following services to be isolated / locked off (if required)					
<input type="checkbox"/> Electricity <input type="checkbox"/> Gas <input type="checkbox"/> Water <input type="checkbox"/> Air <input type="checkbox"/> Other: _____					
<b>Section "B"</b>					
To be filled by Area	I authorize the task / activity to be carried out at above mentioned location for specified time. Executing Department should carry out work in compliance to safety / PPE requirements identified by HSE&QA Department in section 'C' below.				
	Name	Designation	Signature	Date and Time	
<b>Section "C"</b>					
To be filled by HSE&QA	Name	Designation	Signature	Date	
	Following controls must be implemented to mitigate the safety risk/hazard associated with the task/activity:				
	PPE Required: <input type="checkbox"/> Hard Hat <input type="checkbox"/> Safety Shoes <input type="checkbox"/> Cover all <input type="checkbox"/> Reflective Jackets <input type="checkbox"/> Ear Plug <input type="checkbox"/> Ear Muffs <input type="checkbox"/> Dust Mask <input type="checkbox"/> Face Shields <input type="checkbox"/> Welding Shields <input type="checkbox"/> Safety Belt/ Harness <input type="checkbox"/> Safety Goggles <input type="checkbox"/> Hand Gloves <input type="checkbox"/> Breathing Apparatus Others: <input type="checkbox"/> Fire Extinguisher <input type="checkbox"/> Ambulance <input type="checkbox"/> Barricade <input type="checkbox"/> Other: _____				
<b>Section "D" (Monitoring &amp; Closing)</b>					
<b>Area Authority</b>		<b>Executing Department</b>		<b>HSE&amp;QA Department</b>	
I have physically inspected the work site and verified the operational controls are in place.		I declare that the above task / activity has been carried out in compliance with the controls / requirements mentioned above.  The task / activity is now completed and site is safe for routine operations.  Any incident happened during execution: Yes <input type="checkbox"/> No <input type="checkbox"/>		HSE&QA Observations during monitoring (if any):	
				This work permit is now considered close.	
Name	Sign & Stamp	Date	Name	Sign & stamp	Date

MR

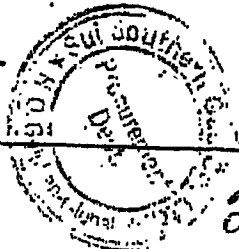

28

 <b>SSGC</b> HSE&QA Department	<b>IMS FORM</b>	SSGC-IMS/CRM-F-04
	<b>Job Safety Analysis Form</b>	
	Revision 01	
		Issue Date: July, 2021

Executing Department		Zone	Date		
Job/Activity:	Activity Details:				
Location:					
<b>PPE Required:</b> <input type="checkbox"/> Hard Hat <input type="checkbox"/> Safety Shoes <input type="checkbox"/> Cover all <input type="checkbox"/> Reflective Jackets <input type="checkbox"/> Ear Plug <input type="checkbox"/> Ear Muffs <input type="checkbox"/> Dust Mask <input type="checkbox"/> Face Shields <input type="checkbox"/> Welding Shields <input type="checkbox"/> Safety Belt/ Harness <input type="checkbox"/> Safety Goggles <input type="checkbox"/> Hand Gloves <input type="checkbox"/> Breathing Apparatus <input type="checkbox"/> Others: <b>Any additional operational controls (if required)</b> <input type="checkbox"/> Fire Extinguisher <input type="checkbox"/> Ambulance <input type="checkbox"/> Barrication <input type="checkbox"/> Other:					
S.No	Steps of field Activity	Potential Hazards	Controls		
<b>Activity Incharge / Supervisor</b>		<b>Head of Executing Department</b>			
I hereby certify that all operational controls, mentioned above, will be implemented at each step of the job. The team is trained to execute the job and the equipment involved in this activity are safe to operate.		I authorize the team to conduct the job. The team is adequately resourced to execute the job safely.			
Name & Designation	Sign & Stamp	Date	Name & Designation	Sign & Stamp	Date

MR

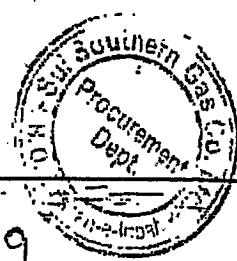



CRM-F-04

 <b>SSGC</b> HSE&QA Department	<b>IMS FORM</b>	SSGC-IMS/CRM-F-05
	<b>Management of Change</b>	
	Revision 01	
Issue Date: July, 2021		

	MOC No: _____	Date   _____
To be filled by MOC Owner	<b>Section A : Description of proposed change and potential hazards</b>	
	MOC Owner _____	Location of Work _____
	Expected Duration of Work _____	
	<b>Type of Change</b>	
	<input type="checkbox"/> Permanent <input type="checkbox"/> Pipeline construction <input type="checkbox"/> Physical structure/building <input type="checkbox"/> New or modification in process/procedure <input type="checkbox"/> Temporary <input type="checkbox"/> New or modification in equipment/machine <input type="checkbox"/> Material <input type="checkbox"/> Substance <input type="checkbox"/> Other: _____	
	Detail of MOC/Scope of MOC: (Summarize the basis for the proposed change and any potential health, safety and environment impacts resulting from the proposed change.)	
The proposed change is now submitted to Area Authority for evaluation.		
	Name & Designation	Sign & Stamp
		Date
To be filled by Area Authority	<b>Section B : Evaluation of the impact(s) related to the change</b>	
	<b>Evaluation Criteria</b>	Yes    No    Comments
	Does the proposed change meet all applicable legal or other requirements?	
	All modifications in the existing process/ equipment are Environmentally Manageable and Safe?	
	Does the change requires changes in SSGC HSE Procedures	
	Does the change will affect the use of Emergency response equipment of the location	
	Does the change requires any specialized training for SSGC staff	
<i>Note: In case of "YES" please provide details on a separate sheet</i>		
The proposed change is now submitted to in charge HSE&QA for authorization.		
	Name & Designation	Sign & Stamp
		Date
To be filled by HSE&QA	<b>Section C : Authorization for change to proceed</b>	
	Following proposed controls should be implemented while execution of the job.	
	Potential hazard/risk	Risk level    Proposed control    Responsibility    Timeline
	Name & Designation	Sign & Stamp
		Date

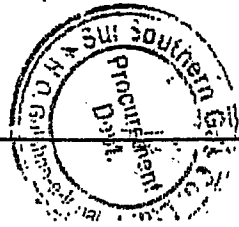
MR



 <b>SSGC</b> HSE&QA Department	<b>IMS Form</b>	SSGC-IMS/CRM-F-06
	<b>Context of the Organization</b>	Revision 00
		Issue Date: July, 2021

**LIST OF INTERESTED PARTIES**

External Interested Parties	Needs & Expectation
<b>Board Of Directors</b>	Profitability, good financial and legal compliance, avoidance of fine and penalty OR <ul style="list-style-type: none"> <li>• Protect shareholders interest.</li> <li>• Ensure adherence / compliance to GOP / SECP guidelines.</li> <li>• Allocate resources to maximize revenue.</li> <li>• Follow best practices of corporate governance.</li> <li>• Ensure committee meetings are held as per plan.</li> <li>• Financial benefits of the organization.</li> <li>• Avoidance of any fines / penalties.</li> <li>• Reputation enhancement.</li> <li>• Corporate Social Responsibility (CSR).</li> <li>• Enhanced corporate governance (CG).</li> <li>• Allocation of all resources to achieve quality goals.</li> <li>• Achievement of safe and healthy conditions in organization.</li> <li>• Commitment to quality, safety and health.</li> <li>• Be prepared to seek advices from industry experts as required.</li> <li>• No major accident at company premises.</li> </ul>
<b>Management</b>	<ul style="list-style-type: none"> <li>• Take policy decisions to increase revenue per employee.</li> </ul>

MR

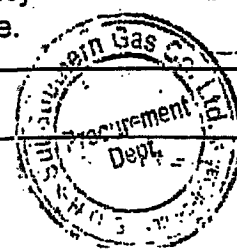



CRM-F-06

 <b>SSGC</b> HSE&QA Department	<b>IMS Form</b>	SSGC-IMS/CRM-F-06
	<b>Context of the Organization</b>	Revision 00
		Issue Date: July, 2021

	<ul style="list-style-type: none"> <li>• Ensure that policy and related objectives are established.</li> <li>• Communicate clear roles to employees.</li> <li>• Develop, lead and promote culture in the organization.</li> <li>• Meet organizational goals by assigning targets to right personnel.</li> <li>• Demonstrate leadership at all levels and functions of the organization.</li> <li>• Effective management of hazards, risks, incident, emergency, and injury.</li> </ul>
	<ul style="list-style-type: none"> <li>• Workers engage and participation in all quality, environment, health and safety activities.</li> <li>• Continued growth in quality and productivity.</li> <li>• Effective controls on quality, health &amp; safety issues.</li> <li>• No major accident at workplace / safe working conditions for all employees.</li> <li>• Develop positive quality and health &amp; safety culture.</li> <li>• Continuously improve quality, safety and health performance with review process.</li> <li>• Well performed employees.</li> <li>• Better staff retention and morale.</li> </ul>
<b>Staff &amp; Workers</b>	<p>Continuation of job, timely wages with all applicable benefits to pay the cost of living, professional development and growth via regular trainings.</p> <p>OR</p> <ul style="list-style-type: none"> <li>• Good and safe working conditions.</li> <li>• Job security.</li> </ul>

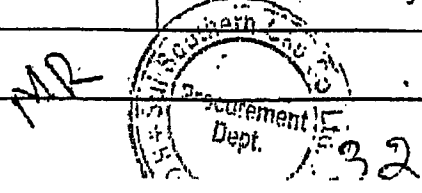
Not for Bidder Purpose



 <b>SSGC</b> HSE&QA Department	<b>IMS Form</b>	SSGC-IMS/CRM-F-06
	<b>Context of the Organization</b>	
		Revision 00
		Issue Date: July, 2021

	<ul style="list-style-type: none"> <li>• Training and development opportunities.</li> <li>• Sustained reputation and image of company.</li> <li>• Consultation.</li> <li>• Communication and participation.</li> <li>• No accident / injury / ill-health.</li> <li>• Reward and recognitions.</li> <li>• Opportunities for dialogue / improvement / changes.</li> <li>• Timely and fair provision of remuneration coupled with career progression.</li> </ul>
<b>Client/Customer</b>	Timely provide high quality services, quick response on any complaint, follow all local laws and QH&S requirements. OR <ul style="list-style-type: none"> <li>• Uninterrupted gas supply.</li> <li>• Customer facilitation.</li> <li>• Quick response of queries &amp; complaints.</li> <li>• Value for money.</li> <li>• No health and safety issue in product.</li> <li>• Prompt actions on quality, health and safety issues.</li> <li>• Minimize the risk of injuries when receiving a services.</li> <li>• Socially and environmentally responsible.</li> </ul>
<b>Suppliers/Contractor</b>	<ul style="list-style-type: none"> <li>• Continuous orders, prompt payments as per agreed terms, good long terms working relationship.</li> <li>• Fair chance of participating in bid opening.</li> <li>• Communication of hazards present at workplace.</li> <li>• Timely payment.</li> </ul>

MR

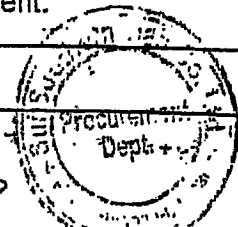

CRM-F-06

 <b>SSGC</b> HSE&QA Department	<b>IMS Form</b>	<b>SSGC-IMS/CRM-F-06</b>
	<b>Context of the Organization</b>	
	Revision 00	
		Issue Date: July, 2021

<b>Trade Union &amp; Worker Representative</b>	<ul style="list-style-type: none"> <li>• Transparency.</li> <li>• Effective implementation of national &amp; local labor laws with any non-conformance, good working relationship with management</li> <li>• Conducive and safe environment for work</li> <li>• Timely provision of information necessary for workers</li> <li>• No fear of dismissal or disciplinary action while reporting near miss / accident.</li> </ul>
--	---

External Interested Parties	Needs & Expectation
<b>Media &amp; NGOs</b>	<ul style="list-style-type: none"> <li>• Media management.</li> <li>• Patient and positive attitude.</li> <li>• Effective communication.</li> </ul>
<b>Visitors</b>	<ul style="list-style-type: none"> <li>• Safe entry and exit during stay at SSGC.</li> <li>• Communication of pertinent information.</li> <li>• Emergency response.</li> <li>• Briefing necessary safety rules.</li> <li>• Necessary PPE available.</li> <li>• Site access controls.</li> </ul>
<b>Emergency Services (Fire/Medical etc)</b>	<ul style="list-style-type: none"> <li>• Good Risk management.</li> <li>• Emergency procedure in place and drilled.</li> <li>• Regulatory compliance.</li> </ul>

MR

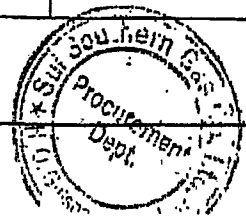

34



 <b>SSGC</b> HSE&QA Department	<b>IMS Form</b>	<b>SSGC-IMS/CRM-F-06</b>
	<b>Context of the Organization</b>	
		Revision 00
		Issue Date: July, 2021

	<ul style="list-style-type: none"> <li>Regular drills for flooding, spillage, site excavation and first aid etc.</li> <li>Availability of adequate resources.</li> </ul>
<b>Utility Providers (Power/water/fuel, Telecom)</b>	<ul style="list-style-type: none"> <li>Prompt payment.</li> <li>Good Management.</li> </ul>
<b>Academic Institutes</b>	<ul style="list-style-type: none"> <li>Effective learning programs for employees.</li> <li>Synchronize the linkage of quality, health and safety with technical and non-technical learnings.</li> <li>Learning from SSGC.</li> </ul>
<b>Insurance Companies</b>	<ul style="list-style-type: none"> <li>No claims, risk management, prompt payment.</li> </ul>
<b>Banks</b>	<ul style="list-style-type: none"> <li>Financial performance, cash flow.</li> </ul>
<b>Neighborhood/Community/ Society</b>	<ul style="list-style-type: none"> <li>Safe working conditions.</li> <li>Environment friendly operations.</li> <li>Contribute positive to local environment and populations.</li> <li>No complaint relating to noise, pollution, waste and employment.</li> </ul>
<b>Share Holders</b>	<ul style="list-style-type: none"> <li>Minimize risk and losses.</li> <li>Increase market capitalization.</li> <li>Return on investment.</li> <li>Transparency.</li> <li>Rights are protected.</li> <li>Good dividend.</li> </ul>
<b>Federal and local law enforcement agencies</b>	<ul style="list-style-type: none"> <li>Pay all applicable taxes timely, follow local laws and regulations with regular updating</li> </ul>

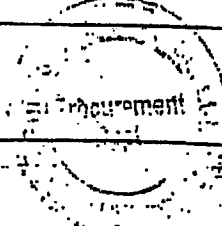



MS-F-06

 <b>SSGC</b> HSE&QA Department	<b>IMS Form</b>	SSGC-IMS/CRM-F-06
	<b>Context of the Organization</b>	Revision 00
		Issue Date: July, 2021

<b>Third party auditors- Finance</b>	<ul style="list-style-type: none"> <li>• Smooth data collection</li> <li>• Better financial performance</li> <li>• Effective communication</li> <li>• On time response on queries</li> <li>• No fraud or illegal acts detection</li> </ul>
<b>Certification bodies</b>	<ul style="list-style-type: none"> <li>• Effective implementation of ISO standards with all relevant clauses in the organization</li> </ul>
<b>Creditor/Financial Institution</b>	<ul style="list-style-type: none"> <li>• Repaid on time, good financial performance</li> </ul>
<b>Government/ Regulators (Local/Regional/Provincial/National/International)</b>	<ul style="list-style-type: none"> <li>• Identified applicable statutory and regulatory requirements for Quality and health &amp; safety.</li> <li>• Prompt responses in case of any non-conformance.</li> <li>• Proper investigation on uncontrollable.</li> <li>• Implementation of safe policy in the field of occupational safety.</li> <li>• Fulfill the requirements of all applicable laws, rules, regulation, orders, guidelines, interpretations and directives.</li> </ul>

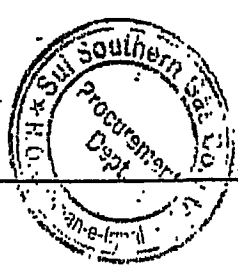
MR



 <b>SSGC</b> HSE&QA Department	<b>IMS Form</b>	SSGC-IMS/CRM-F-07
	<b>SWOT Analysis</b>	Revision 00
		Issue Date: July, 2021

POSITIVE	
STRENGTHS	WEAKNESSES
Having vast experience of Transmission and Distribution of Natural gas.	Complex distribution network leading to UFG.
Infrastructure available in two provinces.	Substantial resources required for up gradation.
Highly competent human resource.	Lack of succession planning.
Certified to international standards.	Takes extra time to implement all requirements because of big size of the organization.
Sole Meter manufacturing plant in Pakistan.	High price.
Serving the nation since decades.	Government new rules implementation.
Positive image of the company is already established in the Society.	Resource transfers.
NEGATIVE	
OPPORTUNITIES	THREATS
Monopolistic market.	Depleting natural gas.
Over 2.8 million customers.	Customers may turn to renewable energy sources.
Import of LNG.	High cost.
Huge infrastructure of Transmission and Distribution to connect new customers.	Gas theft and leakages resulting in huge loses.
Reduction in the lead time to facilitate complainant.	Change in Government policies.
Advancement and use of latest technology to control the system will create more effectiveness.	Criminals threats on security.

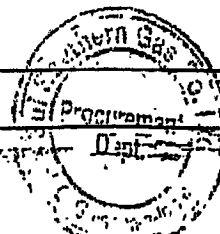

1. PURPOSE

The purpose of this document is to define a mechanism of incident and near miss reporting investigation & propose corrective/preventive actions against near miss, incidents and accidents.

"Anything that can go wrong, will go wrong"

2. SCOPE

This procedure is applicable to all incidents (i.e. accidents & near miss) which take place within SSGC premises or outside SSGC premises i.e. its installations or work-related sites which are under the scope of management system.

3. DEFINITION

- a. **Incident:** Work-related event(s) in which an injury or ill health or property damage (regardless of severity) or fatality occurred, or could have occurred.
- b. **Accident:** An incident in which an injury or illness or property damage actually occurs.
- c. **Near Miss:** A-Near Miss is an unplanned event that did not result in an injury or property damage, but had the potential to do so.
- d. **CPR:** Cardiopulmonary resuscitation.
- e. **Emergency:** An emergency is a situation that poses an immediate risk to health, life, property, or environment.

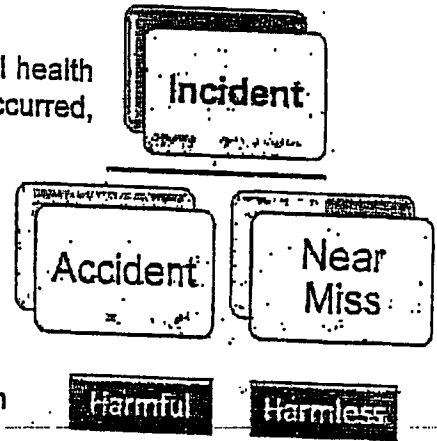

INCIDENT / ACCIDENT LOSSES

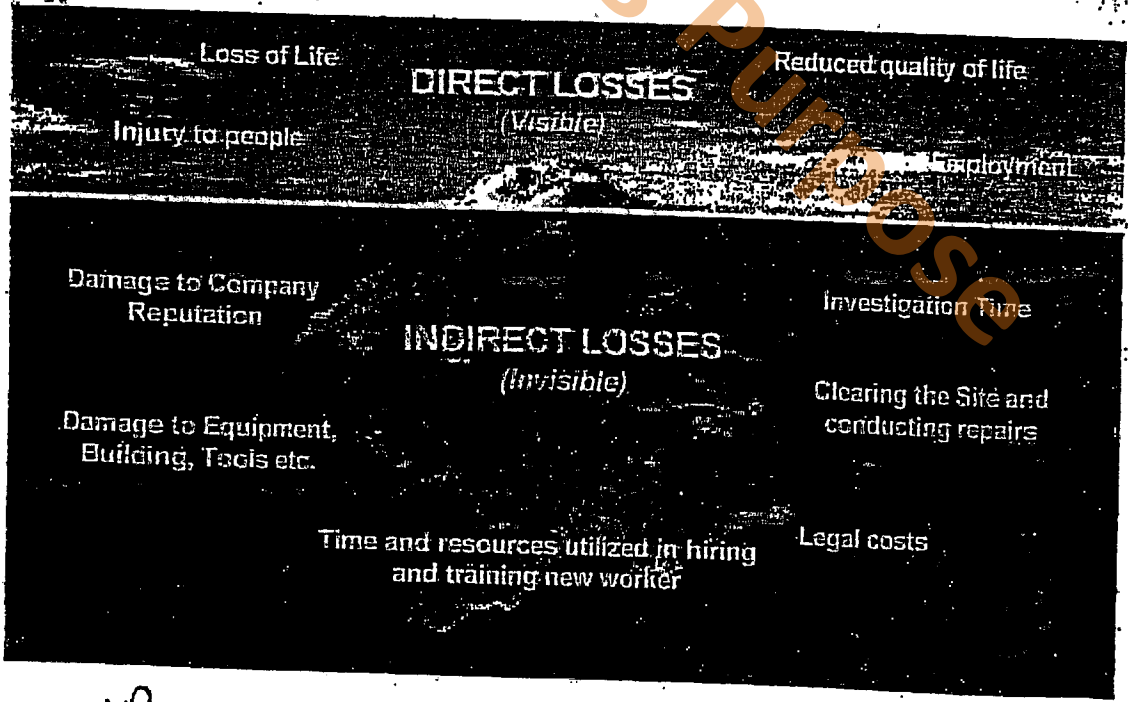

MR

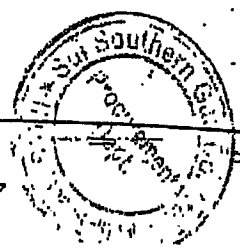

## 4. PROCEDURE

### 4.1. Incident Classification Table

S. No	Incident Type	Classification	Actions to be taken	Responsibilities	Record
1	<ul style="list-style-type: none"> <li>Major fire</li> <li>Major gas leakage</li> <li>Explosion</li> <li>Bomb blast</li> <li>Vehicular accident</li> <li>Significant asset / human loss due to any untoward situation including natural disaster, damage or theft of asset / property having an estimated amount of more than Rs. 30,000</li> <li>Injury/illness serious enough to result in two off workdays:</li> </ul>	Major	Inform respective departmental head/in-charge and immediately call local rescue departments, such as Fire Brigade, Bomb Disposal Squad etc. Thus, whichever is necessary.	Anyone who has witnessed or received initial information about the incident.	
			Follow the Emergency Response Procedure.	Security department in case within SSGC premises, Site/ Zonal HSE team leader in case it is outside the SSGC premises.	SSGC-IMS/ER P-04
			Provide Help/Support to the victims such as First Aid or CPR if needed.	Only trained persons in case of CPR/First Aid is needed.	
			Report the incident using incident notification form via web portal to in-charge HSE&QA immediately (or within 24 hours) after the occurrence of incident.	Zonal HSE Team leader.	SSGC-IMS/IAM -F-01
			HSE&QA will complete the investigation report via web portal within seven working days after receiving incident notification form. Additional days may also be required depending upon the criticality of investigation	HSE&QA	SSGC-IMS/IAM -F-02
			HSE&QA will share the report with all concerned for necessary corrective / preventive actions.	HSE&QA	
			HSE&QA will maintain incident data base using online web portal and will share the information with all concerned to avoid reoccurrence.	HSE&QA	
			Implement Corrective / Preventive action.	Zonal HSE Team Leader and anyone who is identified in Investigation report.	
			Follow-up to verify the implementation of recommended corrective/preventive actions.	HSE&QA	



S. No	Incident Type	Classification	Actions to be taken	Responsibilities	Record
		Major	In case of gas loss, transmission/distribution department will quantify the amount of gas loss and shares the same with concerned departments along with investigation report.	Transmission/ Distribution	
2	<ul style="list-style-type: none"> <li>Minor Injuries where only basic first Aid or less than two off days provided to the victim.</li> <li>Minor Vehicular accidents where there is no significant injury or loss.</li> </ul>	Minor	Inform respective departmental head / in-charge.	Anyone who has witnessed or received the initial information about the incident.	
			Report the incident using incident notification form via web portal to in-charge HSE&QA within twenty four hours of the occurrence of the incident.	Zonal HSE Team leader.	SSGC-IMS/IAM-F-01
			HSE&QA will share the information with all concerned to avoid reoccurrence.	HSE&QA	
3	<ul style="list-style-type: none"> <li>Any Near Miss Occurred / Observed.</li> </ul>		Report the Near Miss using online Near Miss Notification Form via web portal. Enter details as mentioned on the form attach evidence (if any) and submit.	All Employees	SSGC-IMS/IAM-F-03

**4.2. Incident Reporting:**

- Incident that resulted in personnel injury, spill, fire, asset damage etc. will be considered as accidents and will be reported through online Incident Management System within 24 hours after the accident.
- Incident that have not done any damage or lose will be considered as Near Miss and will also be reported via web portal.
- All HSE Zonal Team Leaders are responsible to immediately report any incident took place in their respective Zone.
- All Employees are responsible to immediately report any Near Miss occurred / observed via web portal.

MR

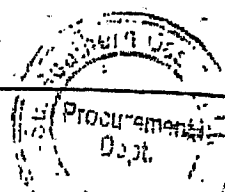

### 4.3. Investigation and Corrective Action

Incidents are investigated by the team constituted by In-charge HSE&QA. If required, a cross functional team may be formed. Depending upon the situation, Incharge HSE&QA will decide whether to investigate or not any major/minor incident/accident, considering following factors:

- a. Severity of the incident/accident.
- b. Time lapse between reporting of the incident and the actual occurrence of the incident.
- c. Lack of supporting information.

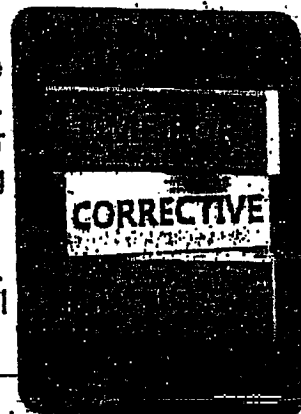

- The investigation is carried out to determine the root cause of the problem. The investigation process covers:
- a. Determination of root cause using any suitable method like tripod analysis etc.
  - b. Investigation will be conducted as soon as possible after the incident, following the activities required controlling the hazard.
  - c. When indicated by the severity of the incident, steps to secure the incident site must be initiated immediately to ensure that investigating party can reconstruct the events leading to the incident.
  - d. Individual interviews will be conducted with each person present at the time of the incident. The following rules are followed for interviews with all individuals:
    1. The witnesses should be interviewed promptly, separately and privately.
    2. The interviewer should avoid questions that give a yes or no answer.
    3. After the interview, the interviewer should document any concerns identified.
  - e. The investigation will be focused at determining the root cause and therefore:
    1. The investigator or investigating team must focus on getting accurate and complete information.
    2. Facts must be separated from opinions, and direct evidence from circumstantial evidence.
    3. Each concern identified in the investigation must be fully addressed.
  - f. Upon completion of the investigation, the team will fill and submit the Online Incident Investigation Form (SSGC-IMS/IAM-F-02). It includes Background Information, Root Cause Analysis, Conclusion and Recommended Corrective / Preventive Actions.
  - g. In all cases, the incident investigation must be completed within 07 working days from the incident notification date. Depending upon the nature of investigation, In-charge HSE&QA may extend the report submission timeline.
  - h. Determination and implementation of viable corrective/preventive actions to eliminate the causes of incident.
  - i. In-charge HSE&QA / Zonal HSE Team Leader ensures that the corrective/preventive actions assigned to concerned department/personnel, to be completed within agreed time frame.
  - j. It is responsibility of the Zonal HSE Team Leader to:



1. Provide leadership role in implementation of corrective/preventive actions within the agreed timescale.
2. Ensure that corrective / preventing actions are effective in eliminating / reducing the risks.
3. Maintain record of Incident Notification Form and Incident Investigation Form of their respective zones.

#### 4.4. Updating of Assessment

After the incident, depending upon the nature of severity and risk, the assessments (risk assessment, environmental aspect impact assessment) of specific activity / department will be updated including controls, risk level, likelihood etc.

#### 4.5. Data Analysis and Review of Actions

The data of incidents will be evaluated and investigation outcomes will be shared with the management during management review meetings to seek advice and to discuss the effectiveness of measures / actions implemented.

### 5. DOCUMENTED INFORMATION

Record No.	Record Name	Maintained by	Retention Period
SSGC-IMS/IAM-F-01	Incident Notification Form	In-charge HSE&QA / Zonal HSE Team Leader	3 Years
SSGC-IMS/IAM-F-02	Incident Investigation Form	In-charge HSE&QA / Zonal HSE Team Leader	5 Years
SSGC-IMS/IAM-F-03	Near Miss Notification Form	In-charge HSE&QA / Zonal HSE Team Leader	3 Years

MR





in the

 <b>SSGC</b> HSE&QA Department	<b>IMS FORM</b>	SSGC-IMS/IAM-F-01
	<b>Incident Notification Form</b>	
	Revision 01	
Issue Date: Aug, 2021		

Date: \_\_\_\_\_ Time: \_\_\_\_\_ Report No. \_\_\_\_\_  
 (To be filled by HSE&QA)

Reported by: \_\_\_\_\_

Location:

SSGC Premises  Outside SSGC Premises

Location Details: \_\_\_\_\_

Responsible Zone \_\_\_\_\_ Zonal HSE Team Leader \_\_\_\_\_

Region \_\_\_\_\_

Particulars of Affected Person(s):		Details of Affected Asset (if any)		
Serial No		1	2	3
Name(s)				
Employee ID(s)				
Designation				
Type of Employment	Permanent			
	Contractual			
	Contractor			
	Visitor			
	Other			
Age				

(Note: For further details additional page may be used)

**Incident Type:**

Fire  Explosion  Vehicular Accident  Asset Damage  Work Related Injury   
 Theft  Sabotage  Natural Disaster  Gas Leakage  Other: \_\_\_\_\_

**Incident Consequences:**

Fatality SSGC  Hospitalization  Asset Damage  First Aid  Other: \_\_\_\_\_  
 Other

**Incident Classification:**

Major  Minor  Near Miss

**Incident Detail:**

MR

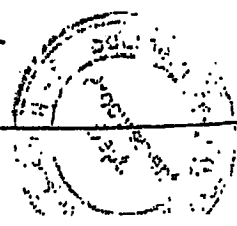

143

 <b>SSGC</b> HSE&QA Department	<b>IMS FORM</b>	SSGC-IMS/IAM-F-02
	<b>Incident Investigation Form</b>	
	Revision 01	
Issue Date: Aug, 2021		

Incident Notification Form Ref. No.		Incident Detail (Brief)
Incident Date		
Investigated by		

**BACKGROUND INFORMATION:**

**ROOT CAUSE ANALYSIS:**

**CONCLUSION:**

**RECOMMENDATION OF CORRECTIVE AND PREVENTIVE ACTIONS**

Recommended Actions	Action by (whom)	Action till (date)
1.		
2.		
3.		
4.		

*Is risk assessment required for the corrective actions? If yes, please mention the serial numbers for the recommended actions:*

**Incharge HSE&QA**

**NOTE:**

1. Please include sketch / photo where ever required to explain the accident scene / conditions
2. Additional pages can be used for mentioning other details
3. Transmission/Distribution department must submit the quantity of gas loss in case of any gas leakage or sabotage.

MR

44

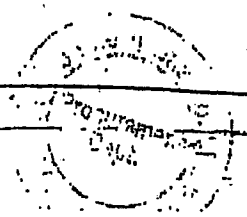

M-F-02

 <b>SSGC</b> HSE&QA Department	<b>IMS FORM</b>	<b>SSGC-IMS/IAM-F-03</b>
	<b>Near Miss Notification</b>	
	Revision 00	
		Issue Date: Aug, 2019

**Personnel Detail (Who Witnessed the Near-Miss):**

Category/Type:     Unsafe Act     Unsafe Condition

Name: \_\_\_\_\_

Executive / Employee No.: \_\_\_\_\_

Designation: \_\_\_\_\_

Department: \_\_\_\_\_

Location / Area: \_\_\_\_\_

**Near Miss Detail:**

Date: \_\_\_\_\_

Time: \_\_\_\_\_

Location: \_\_\_\_\_

Near Miss Related To:

<input type="checkbox"/> Leakage	<input type="checkbox"/> Equipment
<input type="checkbox"/> Slip / Trip	<input type="checkbox"/> Chemical
<input type="checkbox"/> Falling Hazard	<input type="checkbox"/> Biological
<input type="checkbox"/> Fire	<input type="checkbox"/> Transport
<input type="checkbox"/> Electrical	<input type="checkbox"/> Spill
<input type="checkbox"/> Physical	<input type="checkbox"/> Other

Brief description of what you saw! (max. 100 words):

Attach Pictures:

No file chosen

MR



## 1. PURPOSE

The purpose of this procedure is to define a frame work for identification of emergency situations which arise in company operations and for developing emergency preparedness and response plans to mitigate and manage risks arising from such situations or events. The Procedure defines requirements for business continuity planning post emergency situations to bring the business on-line.

Purpose of the procedure is to

- Formulate plan, responsibilities and actions to be taken to handle any emergency situation.
- Identify potential emergency situations and response plans to minimize or avoid actual & potential hazards of any emergency situation.
- Define mechanism and frequency to test plan so as to ensure preparedness and effectiveness of emergency response system.

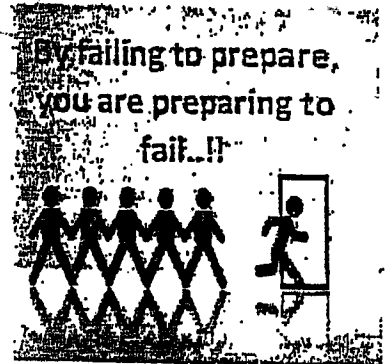

## 2. SCOPE

This procedure is applicable to all locations of SSGC, its employees and any visitor physically present at the location of emergency site. Due to variations in nature of operations, various departments/sections have developed their own ER Plans catering for their strategic, operational and physical requirements. The same includes HSE emergencies arising from company's day to day operations in terms natural calamities, fire, major incidents with loss in our operations, major environmental damage, external terror or bomb threats, public unrest, war and etc.

## 3. DEFINITIONS

- Emergency Situation:** An abnormal situation that calls for immediate and urgent actions for safeguarding life of persons, protecting buildings, machines, vital installations and other assets.
- Rescue:** It refers to responsive operations that usually involve the saving of life or prevention of injury during an incident or dangerous situation.
- Emergency Response Organization (ERO):** It is a group of people, in each section (such as HO, Headquarters etc.), who prepare for and respond to any emergency incident, such as a natural disaster or an interruption of business operations.
- Emergency Response Centre (ERC):** It is a room suitably equipped to handle any potential emergency situations. All emergencies are to be reported here.
- First Aid:** It is the provision of initial care for an illness or injury. It is usually performed by non-expert, but trained personnel to a sick or injured person until definitive medical treatment can be accessed.
- Assembly Areas:** If an evacuation to the outside is appropriate, the nominated assembly areas for personnel shall be far enough away from the building, structure or workplace to ensure that, where practicable, everyone is protected from falling glass and other objects.
- Emergency Evacuation:** It is the immediate and rapid movement of people away from the threat or from the place of the hazard.

## 4. RESPONSIBILITIES

Responsibilities for the particular department/personnel are identified in the response plans prepared by various departments and sections. General responsibilities for Emergency response organization are as under:

- Rush to the area of incident without any delay.
- Immediately assess the situation and initiate the remedial actions.
- Call the fire brigade & other emergency services like ambulances if required.
- Ask/inform all personnel present within premises, using megaphone or any other means, for complete evacuation if situation goes out of control.
- Inform all to go back to their work places using megaphone or any other suitable means when the situation comes under control and the area is free from any hazard.

MR

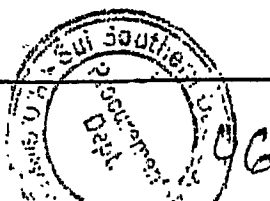

## 5. PROCEDURE

The HSE&QA In-charge and department heads shall ensure that all emergency situations are identified during risk assessments performed and emergency response plans are implemented within the departments. They shall also ensure that all employees are made aware of their emergency situations and how to respond during a real emergency. They shall ensure that employees including emergency team members in their respective departments are trained to respond to emergencies and mitigate risks arising out of real emergencies. Some of the potential emergency situations that might occur in SSGC along with the response plans are listed below. Sequence of actions for any response specified on each section's ER plan may change depending upon the emergency situation.

## 6. Emergency Considerations

The following areas of needs to be given consideration while identifying potential emergency situation but the same need not be limited to these areas:

- Fire & Explosion
- Heavy Spillage of Toxic/flammable chemicals or leakage of gas
- Heavy rain/ flood
- Earth quake
- Bomb threat
- Building & office lockdown/shelter in place
- Active shooter/hostage situation

### 6.1. Fire & Explosion

In case of fire & explosion each personnel present within the premises must act as per but not limited to the following instructions:

- a. Give voice alarm - FIRE! In case of fire for all immediate employees in the area.
- b. Push the nearest located call point button in case of fire (if present);
- c. Immediately inform Emergency Response Organization through phone or in person.
- d. Try to control the fire by using fire extinguishers. Use fire extinguisher only if you have been trained.
- e. Remove all explosive, inflammable and poisonous materials away to the maximum possibility.
- f. Shut off main valves of gas and circuit breakers.
- g. Stay away from the fire in case it is not controllable.
- h. Report to the designated Assembly Point away from the scene of fire / explosion if asked by Emergency Response Organization through emergency exits and wait for the further instructions.



### 6.2. Heavy spillage of toxic/flammable chemicals or leakage of gas

In case of heavy spillage of toxic/flammable chemicals or heavy leakage of Gas each personnel present within the premises must act as per but not limited to following instructions:

- a. Immediately inform Emergency Response Organization through phone or in person.
- b. Eliminate all ignition sources (sparks/flames/heat) from the immediate areas.
- c. Turn off gas supply from nearest control valve.
- d. In case of gas leakage in confined space, proper measures (opening windows, doors etc.) should be taken to ventilate the gas. Ensure the availability of fire extinguishers.
- e. Stop leaks if this can be done without having any risk.
- f. Do not touch or walk through spilled material.
- g. Prevent entry into waterways, sewers or confined space.
- h. If available wear the Personal Protective Equipment recommended.
- i. Arrange immediate cleaning of spilled chemical by taking suitable precautions

No. 11/2019

### 6.3. Heavy Rain / Flood

In case of emergency situation of heavy rain/flood, personnel must remain present within SSGC premises if the situation gets worst outside. In case of water entering in department/office each person must act as per but not limited to the following instructions:

- a. Try to stop water by keeping sand bags.
- b. Protect building, machines, equipment, tools, parts & material.
- c. Shut off Electricity and Gas if necessary.

Following precautions should be taken by the departments/sections, located under rain/flood threat areas:

- a. Ensure no material is placed outside in open area which may be affected by rain.
- b. Ensure proper drainage system at vital installations so that every valve, equipment, electrical board etc. be accessible in case of any emergency.
- c. Sufficient quantity of tarpaulin and rain suit is available to meet the rainy condition.
- d. Keep the drain line open all the time.
- e. All pumps used for draining out the rainy water are in running condition.
- f. Sufficient quantity of sand bags is available to stop entering the water inside, which may be placed in advance if required.

CLASSES OF FIRE			
Class	Material	Examples	Type of Fire Extinguisher to be used
A	Solids	Paper, wood plastic, etc.	• Water
B	Flammable Liquids	Paraffin, petrol, oil, etc.	• CO2 • Dry Powder
C	Flammable Gases	Propane, butane, methane, etc.	• Dry powder
D	Metals	Aluminum, magnesium, titanium, etc.	• Sodium chloride based dry powder fire extinguisher
E	Electrical Apparatus	Short-circuiting, over loaded electrical cables, etc.	• CO2 Fire Extinguisher
F	Cooking Oil & Fat	Animal fat, etc.	• Dry chemical based: Potassium bicarbonate • Wet: Fine chemical mist

### 6.4. Earthquake

In case of earthquake shocks each personnel present within the premises must act as per but not limited to the following instructions:

- a. Immediately inform Emergency Response Organization through phone or in person.
- b. Immediately Evacuate to Assembly Areas (in open space where you can keep distance at least one half of the height of the building) after the shocks dampen.
- c. Shut off all switches and valves of main supplies of gas and electricity. (If possible)
- d. Maintain your senses, do not let them disperse.
- e. Protect yourself by sitting on side of tables, furniture & under strong structures. Be aware of falling walls, debris, heavy objects and electrical wires.
- f. Stay away from loosely hanging objects that may fall after initial shock and tremors.
- g. Wait for further instructions from Emergency Response Organization.
- h. ERO should keep in touch with the metrological department / media for aftershocks and future forecasts.

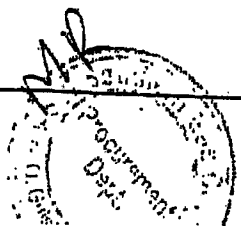

- e. The Bomb Disposal Department shall be allowed to operate in the company premises as deemed appropriate.
- f. On getting clearance from Bomb Disposal Department normal routine shall be adopted as advised by Emergency Response Organization.

**6.5. Bomb Threat**

In case of bomb threat each personnel present within the premises must act as per but not limited to the following instructions:

- a. Immediately inform Emergency Response Organization through phone or in person.
- b. Maintain your senses, do not let them disperse.
- c. Report to the designated Assembly Point if asked by Emergency Response Organization through emergency exits and wait for the further instructions.
- d. Bomb Disposal Department shall be called by Emergency Response Organization.
- e. The Bomb Disposal Department shall be allowed to operate in the company premises as deemed appropriate.
- f. On getting clearance from Bomb Disposal Department normal routine shall be adopted as advised by Emergency Response Organization.

**6.6. Building or Office Lockdown/shelter-in-place**

If a situation calls for building or office lockdown, the personnel present within premises should act as per but not limited to following instructions:

- a. Remain calm and stay with your colleagues.
- b. Try to stay in pairs.
- c. Do not leave the room and/or building under a lockdown situation until asked otherwise.
- d. Keep quiet and away from doors and windows.
- e. If a gunshot is heard, lay down on the floor and shield under/behind furniture as much as possible.

**Take care:**  
 Don't try to be a hero in emergency situations; do not place your own life or health or that of others in danger. Be prepared for the unexpected.

**6.7. Active Shooter/Hostage Situation**

In case of shooter/hostage situation each personnel present within the premises must act as per but not limited to the following instructions:

- a. If it is safe to do so, exit the building; if not, lock or barricade yourself inside a room.
- b. Turn off lights, cover and lock the windows, and lay on the floor.
- c. If the shooter(s) leave the area, go to a safer place, if possible. Have an escape route/plan in mind, keep your hands open and visible, and follow any instructions given by law enforcement.
- d. Call the Police/Rangers when it is safe to do so. Remain calm, use a quiet voice, and provide as much information as possible (your name and location, details about the shooter(s) - appearance, weapons, etc.). If you can't speak, leave the line open so the responding authority can listen and try to pinpoint the location.
- e. Cooperate and negotiate with the shooter, in order to buy as much time as possible until the rescue team reaches.

**7. EMERGENCY NUMBERS**

In consideration of the emergency numbers to be included in the emergency plan, the following should be taken into account:

- Fire brigade/civil defense or equivalent.
- Police.
- Ambulance service.
- Hospitals/Clinics.
- Mutual aid agreements/neighbors.
- Environmental protection agencies.
- Key company personnel.

MR

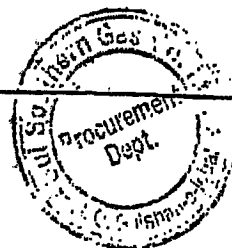

is deemed by

### 8. EVACUATION

All Emergency evacuation routes/doors should be accessible at all times. No hindrances should be placed in the route. All employees should be familiarized with the evacuation routes of their premises. All employees should immediately evacuate their premises and assemble at the assembly areas (identified by each section). During evacuation following instructions should be followed.

- a. Take only keys, wallets and essential belongings with you.
- b. Leave the building/premises immediately, do not try to investigate the source of the emergency.
- c. Walk, don't run, to the nearest exit.
- d. Use stairs, not elevators.
- e. Assist people with special needs.
- f. As you make your way out, encourage those you encounter to exit as well.

### 9. THINGS TO BE EVACUATED

In case of emergency, evacuation should be carried in the following order:

#### 9.1. Personnel

Those personnel who do not have sound health such as patients of Heart, Asthma and physically/mentally disabled people are to be evacuated on priority basis.

#### 9.2. Raw Material

Raw material which is explosive, inflammable and poisonous must be removed. Similarly, important lightweight items that are easy to carry must also be removed.

#### 9.3. Documents

Important records and files must also be removed.

#### 9.4. Equipment

Cash Lockers, Computer Sets, External Hard-drives, Expensive Tools and Fixtures must also be removed.

### 10. TESTING AND EXERCISES

Testing and exercise of the emergency response plan should be conducted at each location of SSGC to evaluate the effectiveness of the preparedness plan. The record and observations of the exercise should be recorded on Emergency Drill Form (SSGC-IMS/ERP-F-01).

Each section should nominate the person who is responsible to periodically conduct the exercise. The frequency and type of drill at each location should be as below:

Location	Type of Emergency Drill	Frequency
a. Head Office b. Regional Offices c. Billing Offices d. P&C Offices e. Store (all locations)	Evacuation and Mock Emergency Drill (all employees)	Six Monthly
f. KT (Transmission) g. Distribution (Zonal and Sub-zonal offices)	Fire Fighting Drill by Emergency Response Team	Six Monthly

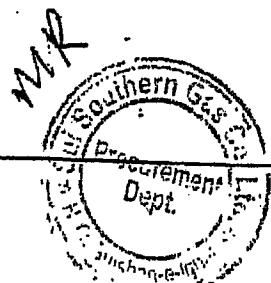



Meter Manufacturing Plant	Evacuation and Emergency Mock Drill (all employees)	Six Monthly
	Fire Fighting Drill by Emergency Response Team	Quarterly
Headquarter Stations	Evacuation and Emergency Mock Drill (all employees)	Six Monthly
	Fire Fighting Drill by Emergency Response Team	Monthly

**11. AVAILABILITY AND MAINTENANCE OF ER EQUIPMENT:**

Zonal HSE team leaders ensure that emergency detection and response equipment are identified, available and properly maintained in their respective zones. A joint inspection will be carried out periodically to verify the efficacy of ER Equipment. The record shall be maintained on Inspection and Monitoring of ER Equipment Form (SSGC-IMS/ERP-F-02). Each zonal HSE team leader shall maintain record of their respective zone and share with In-charge HSE&QA as and when required. The need for the emergency response equipment is determined by considering the hazards and associated risks with the particular location/operation/equipment/installation etc. The response equipment usually include but are not limited to:

- a. Fire extinguisher.
- b. Fire hydrant/hose/bucket/water pump.
- c. Smoke/gas detectors.
- d. Communication equipment. (Mega phones; Alarm systems; walkie-talkie etc.)
- e. First aid box.
- f. ER vehicles/Ambulance.
- g. Breathing apparatus.
- h. Emergency lights.
- i. Hammer/Axe/shovel/ropes etc.

Frequency of inspection and monitoring of ER Equipment will be as per table given below. However, if situation warrants, this frequency can be changed on the instructions of In-charge HSE&QA or Zonal HSE team leader.

Location	Frequency
a. Head Quarter Stations b. Meter Manufacturing Plant c. K.T (Transmission)	Monthly
a. Head Office b. Regional Offices c. Billing Offices d. P&G Offices e. Store (all locations) f. Distribution (Zonal and Sub-zonal offices)	Quarterly

**12. DOCUMENTED INFORMATION:**

Record No	Record Name	Maintained by	Retention Period
SSGC-IMS/ERP-F-01	Emergency Drill Form	HSE&QA Department	3 Years
SSGC-IMS/ERP-F-02	Inspection and Monitoring of ER Equipment Form	HSE&QA Department	3 Years

MR

51

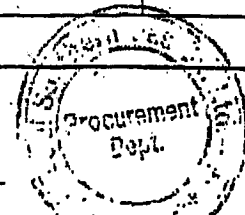

Six Monthly

 <b>SSGC</b> HSE&QA Department	<b>IMS FORM</b>	SSGC-IMS/ERP-F-01
	<b>Emergency Drill Form</b>	Revision 01
		Issue Date: Aug, 2021

Zone	Region	Location	Date
------	--------	----------	------

Type Of Emergency Drill  
 Fire and Explosion  Heavy spillage of toxic/flammable chemicals  Heavy gas leakage  Earthquake  
 Bomb Threat  Other :

S.No	Description:	Observations	
		Time	Comments
1	Emergency Siren rang at		
2	Evacuation started at		
3	Last person reached at the assembly point		
4	Firefighting/Bomb disposal squad/other interested party reached at site		
5	Emergency under control at		

Total time of Drill (minutes):  
 Additional Observations (If any):

S.No	Assessment	Yes	No
1	Emergency responders were present at the site		
2	Employee were properly instructed		
3	Behavior of employees was satisfactory		
4	Evacuation route was satisfactory		
5	SSGC firefighters were well trained		
6	Firefighting equipment were up to the mark		
7	Response of the medical staff was satisfactory		

Overall Assessment: Satisfactory  Unsatisfactory

S.No	Corrective Actions/Improvements Required	Responsibility	Target Date

Security Services Representative		HSE&QA Representative	
Name	Signature	Name	Signature

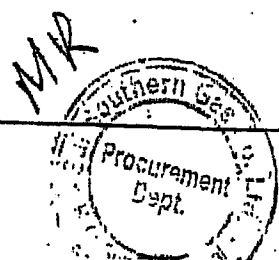

 <b>SSGC</b> HSE&QA Department	<b>IMS FORM</b>		SSGC-IMS/ERP-F-02
	<b>Inspection and Monitoring of ER Equipment Form</b>		Revision 01
			Issue Date: Aug, 2021

Zone	Region	Location	Date
<input type="checkbox"/> Fire Extinguisher <input type="checkbox"/> Fire Hydrant/Water Pump/Buckets/Hose <input type="checkbox"/> Smoke/Gas Detector <input type="checkbox"/> Emergency light <input type="checkbox"/> Ambulance <input type="checkbox"/> First Aid Box <input type="checkbox"/> Communication Equipment <input type="checkbox"/> Other :			
<b>CHECKLIST</b>			
S.No	What to check	Yes	No
<b>Fire Extinguisher</b>			
01	Fire extinguishers are in operable condition and not expired.		
02	Pipe and nozzle do not have cracks.		
03	Lever and lever pin are in place and locked.		
04	All extinguishers are clearly visible and accessible.		
<b>Fire Hydrant/Hose/Bucket</b>			
01	No leakage in fire hydrant system.		
02	Hydrant valves are properly lubricated and operational.		
03	Hose pipe is rolled and properly placed. Nozzles are attached at the end.		
04	Fire buckets are maintained and adequately filled with sand.		
<b>First Aid Box</b>			
01	All necessary/required medicines are available in First Aid box.		
02	Medicines are not expired and valid for use.		
<b>Smoke/Gas Detector</b>			
01	Alarms and Smoke/gas detectors are properly functioning.		
<b>Other Equipment (if any)</b>			
01			
02			
S.No	Observations	Recommendations	
1			
2			
3			
Additional Comments (if any):			
Security Services Representative		HSE&QA Representative	
Name & Designation	Signature	Name & Designation	Signature

Integrated Management System

MR

53



## 1. PURPOSE

The HSE&QA guidelines for suppliers and contractors are developed to assist suppliers/contractors to meet ssgc's hse&qa policies, procedures, commitment & requirements to ensure safety, integrity and quality of goods/services provided.

## 2. SCOPE

The procedure is applicable to all suppliers and contractors providing goods or services to SSGC whether on SSGC premises or outside SSGC premises.

## 3. DEFINITIONS

- a. **Contractor:** Is an independent employer/organization who will be responsible to execute jobs agreed with SSGC.
- b. **Supplier:** Is an independent employer/organization that is responsible to provide goods or services.
- c. **Contract coordinator:** Is an executive of SSGC procurement department, who has been delegated/given responsibility and authority from the head of department to initiate and maintain the contract.
- d. **NEQS:** National Environmental Quality Standards.
- e. **SEPA:** Sindh Environmental Protection Agency.

## 4. RESPONSIBILITIES

### 4.1 Suppliers/Contractors and Sub Contractors

- a. The contractor must take all necessary safety precautions related to the performance of the contract in order to protect the work site, including all personnel and property of the SSGC, the contractor, all third parties involved.
- b. Suppliers/Contractors are responsible for safety and well-being of their employees.
- c. The contractor will also be responsible to provide relevant safety equipment (PPE) to their workforce where required. Suppliers/Contractors who have their own HSE&QA management system, shall provide details of the same on request.
- d. The contractor shall ensure that all personnel are adequately trained to perform the task assigned.
- e. Supplier/Contractor shall ensure compliance with SSGC policies, procedures and applicable legal and regulatory requirements.
- f. The contractor shall adhere to set standards and requirements for environmental protection.

### 4.2 Contract Coordinator

The contract coordinator is responsible to arrange training sessions/meetings between contractors and HSE&QA department within 10 days of issuance of a letter to proceed.

### 4.3 HSE&QA Department

- a. In-charge HSE&QA and contract coordinator are responsible to evaluate the capability and competence of Supplier/Contractor regarding HSE&QA.
- b. In-charge HSE&QA is responsible for providing necessary information and training to Suppliers/contractors regarding applicable SSGC's HSE&QA policies and procedures.
- c. HSE&QA department will carry out inspections and audits to ensure safety and well-being of employees and adherence to set standards, technical specifications and guidelines.
- d. In-charge HSE&QA is responsible to highlight critical nonconformances related to HSE&QA. Strict decisions may be taken against any violation/breaches of SSGC's safety policies/procedures/contract terms during the execution of contract.

## 5. PROCEDURE

- a. The contract coordinator should ensure that this procedure is part and parcel of every contract made by SSGC.
- b. The contract coordinator must notify in-charge HSE&QA to evaluate the capability & commitment of potential suppliers/contractors regarding HSE&QA during technical evaluation phase.
- c. The contract coordinator arranges a meeting between supplier/contractor and HSE&QA department after issuance of letter to proceed. HSE&QA awareness form (SSGC-IMS/GSC-F-01) will be communicated and duly signed by supplier/contractor as well as HSE&QA department.
- d. HSE&QA department will conduct periodic inspection/audit of worksite/supplier facility to identify gaps on issues related to HSE&QA.
- e. The contractor/supplier shall educate and adequately train their employees in order to understand the requirement of this procedure.
- f. Supplier shall adhere to technical specifications provided by SSGC to ensure quality of goods provided.
- g. The contractor shall perform hazard identification and risk assessment related to their activities for the proper implementation of possible controls/personal protective equipment (PPE) or otherwise consult SSGC's HSE&QA department to seek guidance and awareness on risk/hazards related to activity and its possible controls.
- h. The contract is liable to understand and implement "permit to work (PTW), job safety analysis (JSA)" where required. Please refer to risk assessment and management procedure (SSGC-IMS/CRM-02).
- i. The contractors are responsible to dispose of any waste generated during their activities in an environmentally safe & responsible manner.
- j. The contractors must ensure that only trained individuals meeting necessary requirements/skills will carry out the required job.
- k. Any equipment used by contractor during the project must not pose any environmental and/or safety concerns, and should be in accordance with SSGC's safety procedures and NEQS and SEPA set standards.
- l. Any identified hazards discovered by the contractor that is beyond their ability and/or responsibility to fix must be immediately reported to the contract coordinator and HSE&QA department in writing.
- m. The contractors must ensure that the workforce involved must be physically fit and should not carry any contagious disease. SSGC reserves the right to ask for medical examination/tests of any employee. Contractor will bear all expenses incurred during the medical examination/tests.
- n. For contracts related to providing food services/canteen services, medical reports from accredited labs must be submitted to head of administration services department for entire crew once the contract is awarded and annually for following diseases hepatitis B & C, tuberculosis, and chest X-ray.
- o. In case of violations from SSGC safety standards/policies/procedures, actions will be taken to penalize the contractor depending on the severity/recurrence of breaches, as per following matrix:

S. No.	Violation	Action
1	Single Minor Non-Compliance	Verbal warning
2	Multiple Minor Non-Compliance	Written warning
3	Single Major Non-Compliance	Written warning / Stop the work on site
4	Multiple Major Non-Compliance	Written warning / Financial penalization, discontinuation of contract

## 6. ACCESS

- a. Prior to commencement, the contractor will submit a list of their workforce personnel who will be on the site. This data will be updated each time the contractor changes site personnel.
- b. All contractor personnel should park vehicles in the designated parking area. Provisions should be made in advance by the contractor to allow for unloading of equipment and materials inside the facility property. No vehicles shall remain inside the building, except for unloading tools or equipment and vehicles will be subject to search and inspection upon exit.
- c. A written pass by the SSGC representative is required in order to remove tools equipment or material from SSGC property. Toolboxes, lunch box bags, etc., are subject to inspection prior to removal. SSGC will prosecute any person, or persons caught removing SSGC property from the premises.
- d. All contractor personnel should enter and leave premises through the main gate, and will be required to sign in and out upon entering and exiting the property. Security will issue an ID badge to each person upon sign-in and at the beginning of each day all contractors must receive a new badge from security.
- e. Contractor employees must stay in their assigned area(s) at the job site and not visit other areas or make any adjustments to any piece of equipment or device unless authorized to do so by an authorized SSGC representative. Failure to abide by this work rule will result in immediate dismissal from the facility and including prosecution.
- f. Each zone maintains secure work areas with limited access at all times. No one is permitted to override any security device for convenience. If access to a secured area is required contact the SSGC representative for authorization. At no time should contractor or subcontractor employees enter the area without prior authorization.
- g. Any work not performed during normal business hours must be approved in advance by the SSGC representative.
- h. All contractor employees will go through contractor safety/induction training upon initial work at SSGC and annually thereafter. A copy of authorized (current) personnel for contractors will be updated and kept at guard shack.

### 6.1 Tools and Property

- a. For any situation in which the Contractors activity may endanger product quality such as: drilling, welding, removing ceiling tile or any other job which creates metal fragments, shavings or dirt in exposed product of manufacturing equipment areas, approval must be made through the SSGC representative and conditionally approved by the ZTL or representative before work is to commence. The Contractor must abide by conditions established by the Zonal Team Leader or representative to protect the equipment.
- b. Soliciting, selling of any merchandise, gambling or distribution of literature for any cause is forbidden on SSGC property.
- c. Use of company telephones is restricted, unless prior approval is attained from the SSGC representative. Pay telephones are not available.
- d. Horseplay, throwing any object and scuffling are dangerous and forbidden.
- e. Cameras of any kind are not permitted in SSGC/ work site unless prior written approval is attained from SSGC representative.
- f. Guns, knives or any other weapons are NOT allowed on company property in any case.
- g. SSGC expects all contractors and subcontractors to maintain a drug-free and alcohol-free workplace. Contractors shall maintain a substance abuse program that includes post-offer and for-cause testing. It will be the responsibility of the Contractor Management to inform their employees and subcontractors that the use of, or evidence of use of, intoxicating liquor or illegal drugs are prohibited at all times while on Zone property. Reporting for work under the influence of alcohol or drugs will not be tolerated. SSGC management reserves the right to remove any contractor or subcontractor employee from Zone property who is believed to be under the influence of alcohol or drugs. It will be the contractor's responsibility to enforce these rules.

MAR

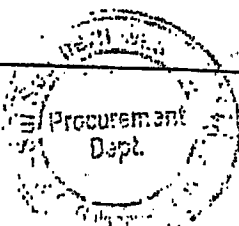

56

- h. Contractor activities are prohibited in overhead areas of the Zone during the times of production or otherwise that may pose a hazard to personnel or product/material. Deviation from this section will be permitted only with the prior consent of the SSGC representative and affected area is isolated and marked off.
- i. Contractor material will not be shipped directly to the Zone without approval of the SSGC representative.

## 6.2 Quality Assurance and Personal Hygiene

While working on SSGC premises or at any worksite;

- a. All persons shall maintain a high degree of personal cleanliness, conforming to the same SSGC standard as SSGC employees.
- b. Pens, pencils, tools and supplies must be carried in a secure manner to eliminate the possibility of product contamination or adulteration, (i.e., nothing is to be carried in shirt pockets, lapel, and etc.).
- c. Appropriate PPEs must be worn by all personnel, including dress as appropriate. Contractor is responsible to provide PPE to their workforce.
- d. Proper clothing must be worn at all times. No tank tops, cutoff shirts, or short pants will be allowed. Jewelry and rings are safety and contamination hazards and are not to be worn in working areas.
- e. Persons with suspected communicable diseases, respiratory infections, infected open cuts, sores or skin abrasions will not be permitted to work in any area that could result in contamination of SSGC personnel.
- f. The use of tobacco in any form is prohibited at all times except in the designated Smoking areas.
- g. Chewing gum, candy, storing lunches, eating or drinking beverages are not permitted in or adjacent to the SSGC premises and storage areas. There will be a designated area for contractors to eat. (Cafeteria)
- h. In the event that there are open tanks, or exposed product/materials, containers or storage, the contractor must erect temporary partitions to eliminate the possibility of any foreign material. (This shall include: grinding, cutting, core drilling, masonry work, jack hammering, chipping, metal drilling, pipe threading, wiring, welding and other hot work, etc., where any dust, mist, chips or other debris may be generated.)
- i. The use of containers, boxes, cans, jugs etc., for holding or storing parts, lubricants, solvents or construction material is strictly prohibited.
- j. The contractor is responsible to notify the SSGC representative immediately if foreign material used or generated by the contractor's activity, was accidentally spill into the zone area/ SSGC premises.
- k. Contractor will follow 'Spill Response Procedure' of SSGC in case of any spill occurred.

## 7. CONTRACTOR SAFETY REQUIREMENTS

### 7.1 General Safety Rules

- a. All applicable Occupational Safety and Environmental regulations must be followed.
- b. Contractors shall supply to their personnel and to the SSGC representative: emergency contact SSGC, phone numbers, and pager numbers as well as emergency procedures appropriate to their on-site work.
- c. Contractors shall provide the SSGC representative with a current copy of their Safety Program including: Confined Space Entry, Lockout/Tagout, and Hazard Communication procedures (if applicable) and associated training certificates.
- d. The Contractor shall supply all required first aid supplies and safety equipment to support his/her personnel.
- e. Contractors are responsible for providing all required Personnel Protective Equipment (PPE). Contractor employees and subcontractors are required to adhere to all established and/or posted PPE requirements while on SSGC property. Industrial grade safety shoes and safety glasses with side shields are required to be worn at all times. Hearing protection in designated areas.
- f. Only SSGC personnel may operate any valve, electrical switch or other equipment connected to operating sections of the Zone unless prior authorization has been obtained from the SSGC representative. Lockout/Tagout is the standard for energy isolation and MUST be adhered to at ALL times with no exceptions. Contractors are responsible for using their own locks and tags for completing their lockouts. In addition, SSGC personnel may initiate we/they lockout system to ensure compliance.

MR

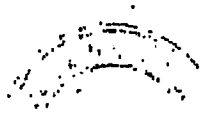

57

- g. Contractor, contractor employees or subcontractors are NOT authorized to dismantle, shut down, or otherwise make ineffective any fire protection device or system. This requires a special permit obtained by the Zonal Team Leader.
- h. Materials, tools, equipment and supplies will be stored neatly and safely so as not to obstruct roadways, walkways, stairways, emergency doors etc., or allow any condition which may be a potential safety or fire hazard. No tools or materials should be left on steps, walkways, platforms elevated equipment, pipes or overhead areas.
- i. Materials are not to be thrown or dropped from scaffolds or other overhead areas.
- j. Fire lanes and aisles to firefighting equipment are to be left unobstructed at all times. Contractors are to provide fire extinguishers for each welding and burning operation and complete HOT WORK PERMITS.
- k. Material should not have been kept in such a way to block access to fire extinguishers, fire doors, hydrants or manhole covers.
- l. All electrical equipment must be properly grounded.
- m. Any lights carried into and used in a hazardous location must be explosion-proof type and suitable for use in the hazardous area involved.
- n. Use of explosive actuated fastening tools should be used according to the manufacturer's safety guidelines.
- o. All compressed gas cylinders must be supported and secured standing upright according to Pakistan standards. When hoses and valves are removed from cylinders, a protective cap is to be installed on all tanks whether empty or full. Acetylene cylinders, when in use must have a wrench in place.
- p. Areas where overhead hazards, excavations or other unsafe conditions exist must be properly blocked off with appropriate warning signs. In the case of an excavation, barricades must be provided. In reference to night excavation projects, night lights shall be provided by the contractor.
- q. In the event an oil, gas, vapor or other harmful volatile release is caused or discovered, the contractor and/or his employees shall report it at once to the nearest SSGC office and request for further actions immediately.
- r. Vehicles in Zone are required to adhere to the declared speed limit.
- s. Any contractor, contractor employee or subcontractor violating Zone area safety or security rules shall be subject to immediate dismissal.

**7.2 Accident Reporting.**

- a. Accidents occurring in Zone jurisdiction must be reported immediately to the SSGC representative.
- b. In the event of a fire, medical or other emergency, contractors are required to notify zone security or the SSGC representative immediately. When providing notification give all pertinent information, including your SSGC, location, and emergency situation involved.
- c. All contractor injuries requiring medical assistance beyond basic first aid must be reported in writing with a full investigation within 24 hours of the occurrence (Contractor Accident Investigation Form). This report must be submitted to the SSGC representative for forwarding to the HSE& QA Department.
- d. All contractors and subcontractors must maintain their own OH&S required document/record.

**7.3 Confined Space Entry**

- a. The SSGC representative will notify the Contractor prior to being hired, if the work will involve entry into confined spaces. The form included in documents will be used to make this notification.
- b. All Contractors who conduct confined space entries must adhere to the SSGC confined space entry requirements.
- c. At no time shall a contractor, contractor employees or subcontractors enter a confined space in Zone without specific authorization from the SSGC representative. Failure to adhere to this policy will result in immediate dismissal.
- d. All contractors are required to keep and maintain their own equipment for confined space entry.
- e. In the event of a confined space entry by contractors, their employees or subcontractor, a standby rescue team must be assembled in Zone assembly area. This rescue team may be SSGC personnel or contractor personnel, however, all arrangements must be made and documented prior to entry.
- f. All contractors and subcontractors who enter a confined space, serve as entry supervisors or rescue team members must have the appropriate training and certification according to the Zone requirements. Copies of all training certification documents must be provided to the SSGC representative & HSE&QA Department.

Integrated Management System

MR

58

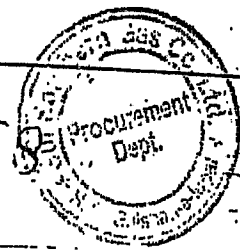



Shut down, or  
tagged by the  
SSG

7.4 Cranes and Overhead Work

- a. All Contractors who conduct work at height, e.g., all work occurring at an elevation above 72 inches without a standard railing must adhere to the SSGC Work at Height Requirements.
- b. All work at height requires the use of a safety harness. All safety harnesses, lanyards and related fall protection equipment must comply with applicable local and ANSI requirements.
- c. All contractor employees working in forklift baskets, scissors or man lifts are required to wear a safety harness.
- d. Working with cranes and derricks require compliance with the SSGC Lifting Equipment requirements and the equipment manufacture's recommendation. Zones and generally accepted practices for safety operating and rigging procedures and methods must be used.
- e. All cranes used on company property must be inspected once per shift and any problems identified must be corrected prior to crane usage. Copies of all inspection records must be provided to the SSGC representative upon request.
- f. In the event that overhead work must occur in locations within the Zone where high voltage, overhead power lines are located, all cranes and overhead lifting devices must maintain a 10-foot clearance. In the event proper clearance cannot be maintained, the power lines are to be de-energized and locked out prior to performing work. In the event the lines must be de-energized, prior approval must be given by the SSGC representative.

7.5 Hazardous Energy Control (Lockout) Procedures

- a. All contractors, contractor employees and subcontractors must comply with the SSGC Energy Control Requirements.
- b. In the event that a contractor, contractor employee or subcontractor servicing or entering a piece of machinery where the danger of injury exists from unexpected energizing of the equipment or unexpected release of stored energy, the contractor or contract employee must disconnect the source of energy and lock/tag out this equipment before beginning work.
- c. In the event that SSGC employees or other unknown persons have locked/tagged out equipment, the contractor is not to remove the lock/tag or energize the equipment. Likewise, the contractors are not to LO/TO any machinery without approval of SSGC representative or remove LO/TO without communicating to all affected associates.
- d. Contractors are required to supply their own lockout locks, tags and hasps.
- e. In the event that a contractor or subcontractor has de-energized and locked out a piece of equipment, the equipment specific lockout procedure must be adhered to. A contractor, contractor employee or subcontractor can acquire the specific equipment lockout procedures from the SSGC representative.
- f. The lockout tag used by the contractor must have the contractor's phone number and a person name, SSGC to be contacted concerning the lockout.

7.6 Zone Equipment and Tools

- a. Contractors will provide their own equipment to their employees.
- b. The use of SSGC vehicles and equipment is prohibited for contractors. Contractors can only acquire this authorization from the Zonal Team Leader. Authorization, when provided, will be documented by use of the Equipment Loan and Indemnification Agreement. Use of all shop equipment is prohibited.
- c. Misuse of SSGC material, equipment or products is prohibited.
- d. The use of SSGC powered industrial vehicles (i.e. forklifts) is strictly prohibited. In the event that SSGC forklifts are required, they can only be operated by certified SSGC employees. There will be no exceptions to this policy. Any contractor, contractor employee or subcontractor who operates an SSGC forklift will be requested to leave the property immediately.
- e. All contractors, contractor employees or subcontractors who operate a powered industrial vehicle in Zone Area must possess a current operator certification.

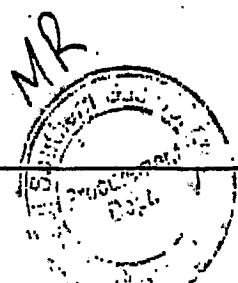

### 7.7 Hazard Communication

- a. Contractors, contractor employees or subcontractors who bring hazardous chemicals on-site, must prior to bringing them on-site:
  - i. Provide the SSGC representative with a listing of all hazardous chemicals.
  - ii. Properly label all containers, adhering to SSGC labeling requirements.
  - iii. Provide the SSGC representative with copies of all SDSs (Safety Data Sheet) for the hazardous chemicals.
- b. The SSGC representative will provide all contractors with a list of hazardous chemicals that the contractor, contractor employees, or subcontractors will come in contact with during the work on Zone property.
- c. At no time should hazardous materials or fuels be left unattended in open containers or unsecured areas overnight, during weekends, or during holiday periods. Temporary storage of such material must be reviewed with the Company representative.
- d. When the use or storage of explosives or other hazardous materials or equipment is necessary for the execution of the work, the Contractor shall exercise the utmost care and shall carry on such activities under the supervision of properly qualified personnel and in conformance with all applicable Zone Requirements and local environmental and safety regulations.
- e. The contractor shall be responsible for all necessary Personal Protective Equipment (PPE), training, and informing their employees of all hazardous substances in use at the job site and of the appropriate safety procedures and policies.

### 7.8 Emergency Procedures

- a. In the event of a fire, medical or other emergency, Contractors are required to notify zone security or the SSGC representative immediately. Tell the security personnel the location of the fire and any other pertinent information. In the event that Zone security or SSGC representative cannot be reached, evacuate the area and call area/city emergency department as soon as possible.
- b. All contractors, contractor employees and subcontractors are required to follow the predetermined exit routes and emergency evacuation procedures posted at the facility.
- c. All contractors, contractor employees and subcontractors are required to exit the work area/building in the event of emergency alarm activation or if instructed to by an SSGC representative. In the event of an evacuation, contractors are required to go directly to the employee staging area located at guard shack.

### 7.9 Gasoline and Propane Powered Equipment

- a. Contractors are required to inform the SSGC representative of any propane or gasoline powered equipment that is to be used indoors.
- b. SSGC Management discourages the use of internal combustion engines indoors, and will only permit it when no reasonable alternative means are available to complete the job.

### 7.10 Temporary Electrical Connections

- a. All wiring & electrical installations are expected to follow National Electric Code practices.
- b. All temporary electrical hook-ups for equipment must be approved by the SSGC representative, prior to installation. All temporary installations must be removed as soon as the task requiring them is complete.
- c. Electrical outlets for portable power tools not a part of permanent wiring of the building should have ground-fault circuit interrupters (GFCI).

Integrated Management System

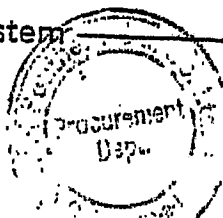

MR

### 7.11 Cutting, Welding and Other Hot Work

- a. All Contractor and subcontractor employees must comply with the SSGC Cutting, Welding and Other Hot Work procedure.
- b. The SSGC representative will issue the Cutting-Welding-Hot Work Permit after confirming that the necessary precautions have been taken.
- c. The permit is valid for ONE SHIFT ONLY. When the work overlaps with the next shift, the SSGC representative will issue a new permit.
- d. The contractor employee designated as the "fire watch" shall sign the permit after the final check has been made and return the signed permit to the SSGC representative.

### 7.12 Ladders and Scaffolding

- a. All ladders belonging to the contractor must be labeled with the contractor's SSGC and possess safety feet and meet SSGC Work at Height Requirements.
- b. All ladders used on Zone property must be properly secured.
- c. All scaffolding must be equipped with railings and toe boards.
- d. All "swinging" type scaffolds must be inspected by the contractor and repaired if necessary before use.
- e. All overhead work from a forklift must be conducted from a secured safety cage. Standing on forks or pallets is not permitted.

## 8. CONTRACTOR ENVIRONMENTAL RULES

SSGC requires that contractors comply with all applicable environmental rules & regulations.

### 8.1 Non-Hazardous Waste

- a. Construction refuse and debris will not be allowed to accumulate and will be removed daily by the contractor at its expense, unless otherwise negotiated in the contract document.
- b. Contractors shall take ownership of all waste and debris generated from materials they brought to the job site or from demolition activities, and shall dispose of such waste and debris in accordance with all applicable laws and regulations.
- c. Reference to SSGC, The SSGC Company or any of its trademarks shall not be used in any documentation associated with the disposal of such waste and debris.
- d. Contractors shall coordinate with the Zone, whenever practical, to segregate debris or waste which may be recycled or re-used in a safe and environmentally responsible manner.
- e. Worksites may be periodically inspected by the SSGC representative to ensure that the contractor is fulfilling its obligations under its contract. Final payment will be withheld until such time as the worksite and property have had a final inspection and removal of all containers, debris, wastes and materials has been confirmed by the SSGC representative and documentation has been printed that all hazardous wastes have been properly disposed.
- f. For those contractors working outside, it is illegal to dispose of any liquid, including water, onto the ground/outside drain for any reason. All water, provided it was not contaminated, shall be disposed of at a drain inside of the facility.

### 8.2 Hazardous Materials

- a. Contractors, contractor employees or subcontractors who bring hazardous chemicals on-site, must prior to bringing them on-site:
  - i. Provide the SSGC representative with a listing of all hazardous chemicals.
  - ii. Provide the SSGC representative with copies of all MSDSs for the hazardous chemicals.
  - iii. Properly label all containers, adhering to SSGC labeling requirements.

MR



- b. No hazardous wastes will be placed or discarded into any drain or sewer on SSGC property. Sewers include: process sewers, sanitary sewers and stormwater sewers. Contractors shall use drain covers, dikes or other appropriate means to prevent a potential release into a drain. In the event that material enters an SSGC sewer, the contractor shall notify the SSGC representative immediately.
- c. Contractor is solely responsible for any and all hazardous wastes generated by contractor's activities on the property. All hazardous material/waste generated by contractors must be disposed of in an approved container and properly labeled. It is the contractor's responsibility to properly dispose of all waste and hazardous materials, and remove containers that store or contain any waste or hazardous materials. Such containers/materials shall be removed from SSGC's property daily and shall be properly disposed of by the contractor/supplier in accordance with all applicable Federal, State and Local laws, rules and regulations. No waste, containers, debris, etc., are to be disposed of in SSGC dumpsters by Contractor, without approval from the SSGC representative. At no time should hazardous waste be manifested or labeled with reference to The SSGC Company or any of its zones or subsidiaries without authorization from the SSGC representative or Zone HSE Manager.
- d. The contractor shall assure that all employees dealing with hazardous materials and hazardous wastes have had all legally required training and are familiar with the hazards presented by such wastes or materials.

**8.3 Spill Response Procedures**

- a. Each contractor is required to have a written emergency response plan to handle spills and releases which may occur during transport, delivery, or use of hazardous materials at the SSGC work site. The contractor must provide a copy of its emergency response plan to the SSGC representative prior to beginning work.
- b. Each contractor must provide and be equipped with appropriate spill response equipment. All contractors, contractor employees or subcontractors who engage in the emergency response of a hazardous material release must have been trained and have the appropriate spills response certification and meet response requirements.
- c. Contractor must provide documentation to verify that it has contracted with at least one reputable outside spill response contractor, that is reasonably agreeable to SSGC, to respond to larger spills or releases which may occur during transport, delivery or use of hazardous materials.
- d. The contractor shall be responsible for appropriate clean-up of spills caused by their activities. Such clean-up will include removal or remediation of any materials impacted by such spill, such as: building materials, soil, groundwater or surface waters, etc.
- e. In the event that a spill or release of contractor's material occurs on SSGC's property and the contractor does not respond to the release to the satisfaction of SSGC, SSGC shall have the right to take any reasonably necessary steps to respond to or remediate such spill or release. The Contractor shall reimburse SSGC for all costs incurred by SSGC to respond to such spill or release.
- f. Spills and releases of hazardous materials must be reported immediately by the contractor to the SSGC representative.
- g. Any spill or release that exceeds an applicable reportable quantity must be reported by the contractor to the appropriate governmental agencies according to applicable laws and regulations. Prior to notifying the responsible outside parties (i.e., governmental agencies), contractor shall first inform SSGC of its intent to report such spill or release.
- h. Contractor is also bound to follow SSGC's 'Spill Response Procedure'.

**8.4 Special Circumstances**

SSGC acknowledges that, from time to time, specific work regarding hazardous materials investigation or response may occur. Under such circumstances, the contractor shall supply a copy of the Work Plan (WP) and Health and Safety Plan (HASP) to SSGC for review and approval prior to commencing work.

MR

Integrated Management System

62

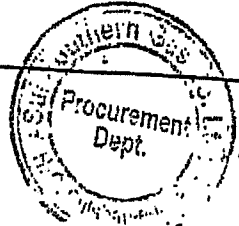

## 9. CONTRACTOR ACCEPTANCE OF WORK RULES AND REQUIREMENTS

All contractors are required to sign a statement that they have received a copy of this program and have read and understand the program. Each contractor shall sign the following Contractor Acceptance of Work Rules and Requirements form and return it to the SSGC representative. A copy will be kept in the project management file and the Zone's HSE Manager's files.

In consideration of admission to the premises of SSGC, we agree to hold in strict confidence and not to divulge to any other person or entity all proprietary information observed or disclosed by SSGC personnel. This includes information that relates to SSGC's past, present, or future research, development and business activities or any client or customer to whom SSGC provides services and/or materials. We will not remove any document, material, or equipment, nor photograph or record any data without specific written permission from a duly authorized representative of SSGC.

This agreement of confidentiality will terminate only when and as SSGC proprietary information becomes public knowledge.

We have read and understood the visitor agreement and will abide by the document while visiting the SSGC facility as required.

## 10. CONTRACTOR ACCEPTANCE OF WORK RULES AND REQUIREMENTS

The undersigned hereby acknowledges that we have received a copy of the SSGC Contractor Work Rules. We have read and will be able to abide by the items listed in the SSGC Contractor Work Rules. We understand and agree that any persons and/or contractors who violate these rules will not be permitted to work for SSGC. We also understand that we are responsible for ensuring that all employees working directly for us, as well as any contractor and/or subcontractors that we hire, comply with these rules.

Compliance with the SSGC Contractor Work Rules does not in any way relieve any contractor or person from complying with any applicable Federal, Provincial or local safety, environmental and other regulations which may apply. The work rules are only a compendium of certain legal requirements and Zone policies. They are not an exclusive discussion of any and all legal requirements applicable to contractors and/or suppliers.

The undersigned represents and warrants that we shall comply with all applicable Federal, State and Local laws, regulations and rules while we are engaged to work or perform services for SSGC, including but not limited to any and all OSHA, Federal, EPA, Sindh, and other health, safety, and environmental requirements. In addition, in consideration of SSGC hiring us, we hereby agree to indemnify and hold harmless SSGC against any and all liability, including defense cost and attorneys' fees, arising from or relating to breach of the above warranty and/or any violation of applicable laws, regulations and/or rules.

MR

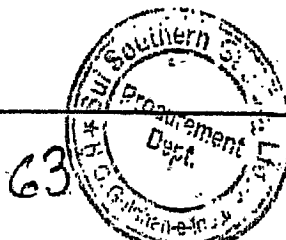

Company \_\_\_\_\_

Date \_\_\_\_\_

SSGC (Print) \_\_\_\_\_

Signature \_\_\_\_\_

Title \_\_\_\_\_

SSGC Representative \_\_\_\_\_

cc: Project Manager File  
Zone HSE Manager  
Contractor

**11. DOCUMENTED INFORMATION**

Record No.	Record SSGC	Maintained by	Retention Period
SSGC-IMS/GSC-F-01	HSE&QA Awareness Form	HSE&QA Department	3 Years

MR



 <b>SSGC</b> HSE&QA Department	<b>IMS Form</b>	<b>SSGC-IMS/GSC-F-01</b>
	<b>HSE&amp;QA Awareness Form</b> (Guidelines for Suppliers and Contractors)	
	Revision 01	
		Issue Date: Aug, 2021

Organization Name		Contact name	
		Contact number	
Type of Contractor <input type="checkbox"/> Mechanical Work <input type="checkbox"/> Electrical Work <input type="checkbox"/> Civil Work <input type="checkbox"/> Waste Disposal <input type="checkbox"/> Canteen <input type="checkbox"/> Transport <input type="checkbox"/> Manpower Contractor <input type="checkbox"/> Pipeline Construction <input type="checkbox"/> Third party inspection <input type="checkbox"/> Goods Supplier <input type="checkbox"/> Other:			
Area of Working:			
Contract Coordinator:			
<b>HSE&amp;QA Awareness</b>			
Description		Remarks	
ISO & OHSAS Standards			
HSE&QA Policy			
PPE Policy			
Risk Assessment and Management Procedure			
Incident and Accident Management Procedure			
Emergency Response Procedure			
Technical Specifications/Performance and Testing Criteria			
Remarks:			
<b>Supplier/Contractor Representative</b>			<b>HSE&amp;QA Representative</b>
I have received and reviewed the SSGC's HSE&QA Requirements and understand that the requirements will be applicable while supplying goods, works or services within company premises or outside company premises. I shall make sure all employees of our company and Sub-Contractor companies understand and agree to the requirements applicable to the activities our company will be performing.			I have met the Supplier's/contractor's representative and provided basic information of HSE&QA Policies and Integrated Management System. The Contractor has shown its commitment in adherence to Company's HSE&QA Policies/procedures/technical specifications /and related requirements to ensure quality, safety and integrity of the goods/services provided.
Name	Signature	Date	Name

MR

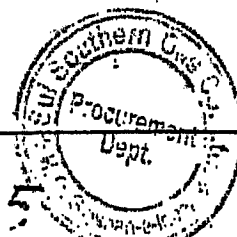

# PENALIZATION MECHANISM

*MR*  
for Service Contracts Only

## 1. Penalization

SSGC management reserves the right to penalize the service contractors in case of any nonconformance during course of the project (addressed in respective ToR / Tender Documents in detail). Penalization will vary according to severity of nonconformance and mode of penalization is provided in respective Terms of References. SSGC management decides the mode and degree of penalization.

### 1.1 Penalization mechanism

Following flow chart depicts the mechanism/ hierarchy, which will be followed for the penalization of the contractor. Penalization Form and *Annexure-J-1* can be found below.

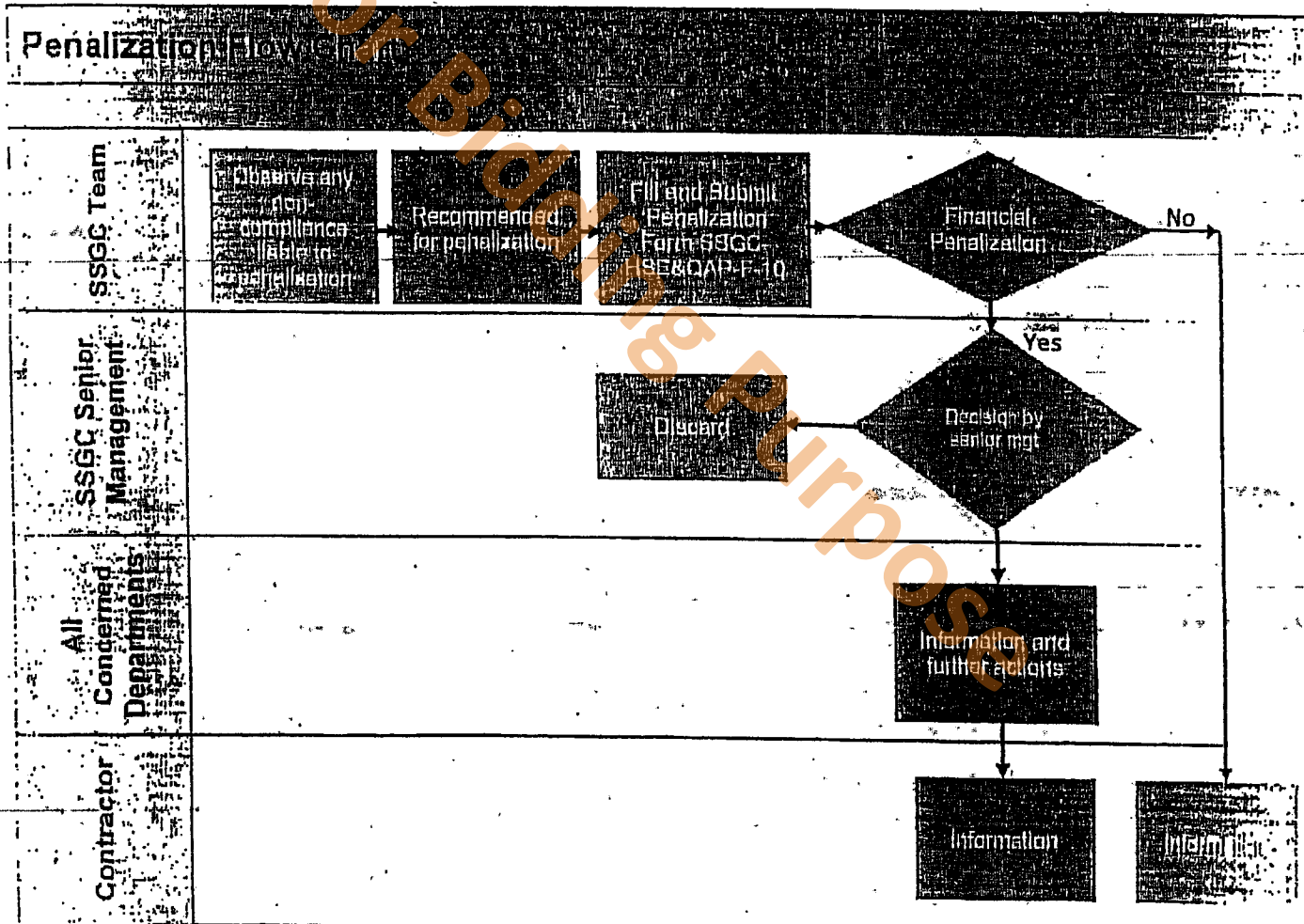

*MR*  
*Qash*

*MR*

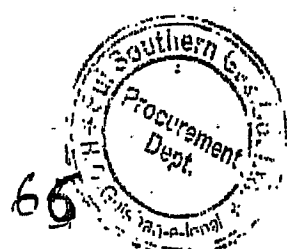

65



## PENALIZATION MECHANISM

Revision 01

MSE&QA  
Department

ANNEXURE J-1

Issue Date: Sep, 2023

## Ethics &amp; Conduct

11	Non-cooperation with SSGC team by any staff of Contractor. Non-cooperation includes non-sharing of construction site data, supporting documents, future work execution strategies etc. compliance of Company protocols or instructions related to works given by SSGC's representative(s).	Removal from duties in case the request is made against this non-Compliance  Note: Approval will be taken from contractor owner i.e. User Departmental Head.
12	Repeatedly (03) absence/Unavailability of site Contractors staff during surprise visits of SSGC teams	Financial penalization (One day salary deduction of entire site staff of audited site)

- Note:
1. Penalization amount will not exceed the 5% of the total contract value.
  2. If Three (03) non-compliance (on any one issue or combination of issues) are issued to any contractor, Management will decide to impose additional penalization (e.g. forfeiting of Performance Bank Guarantee / retention money), termination of contract or temporary blacklist (Blacklisting will be up to one (01) year).
  3. Tender/ Project specific requirements and penalization are outlined in tender documents/ ToR under special requirement section.



Handwritten signature and initials.

MR